



 TRINCIA ARGINI

 OFFSET MOWER

 BROYEUR D'ACCOTEMENT

Del Morino
FARM & GARDEN EQUIPMENT



CENTURION SUPER

HP 15-60



106 cm - 132 cm - 158 cm



Green ideas



Ethics



Partnership



Impact



TRINCIA ARGINI
Polivalente e pratica per l'agricoltore professionista. Trasmissioni ad alta tecnologia. Affidabile, di qualità.

OFFSET MOWER
A practical, multipurpose flail mower for the professional farmer with high-technology power transmission system. The quality and performances are outstanding.

BROYEUR D'ACCOTEMENT
Polyvalent et pratique pour l'opérateur professionnel. Transmissions à haute technologie. Fiable, de qualité.

STANDARD

- attacco a 3 punti 1° e 2° categoria con spostamento idraulico
- riduttore in ghisa 540 g/min con ruota libera
- trasmissione a 3 cinghie con tenditore a vite registrabile
- rotore a coltelli o a mazze
- rullo posteriore regolabile
- cardano standard 4° categoria

STANDARD

- 3 point hitch category 1 and 2, with hydraulic side shift
- cast iron gear box 540 g/min with free wheel device
- 3 belt drive with screw adjustable tensioner
- rotor with blades or hammers
- adjustable rear roller
- universal pto shaft category 4

STANDARD

- attelage à 3 points catégorie 1 et 2, déport hydraulique
- boîtier en fonte 540 t/min avec roue libre
- transmission par 3 courroies par tendeur à vis réglable
- rotor avec couteaux ou marteaux
- rouleau arrière réglable
- cardan standard catégorie 4

 rotore coltelli

 blades rotor

 rotor couteaux

 rotore mazze

 hammers rotor

 rotor marteaux





PUNTI DI FORZA:

- telaio robusto
- rotore sovradimensionato
- rullo posteriore di grandi dimensioni
- 3 cinghie sovradimensionate

STRENGTHS:

- strong frame
- oversized rotor
- big diameter rear roller
- 3 oversized belts

POINTS FORTS:

- châssis robuste
- rotor surdimensionné
- rouleau arrière de grandes dimensions
- 3 courroies surdimensionnées

TYPE											
MODEL	HP	cm	in	cm	in	cm	in	n.	n.	kg	lbs
CENTURION SUPER 106	15 - 60	106	42"	120	50"	3-10	1-4	32	16	290	638
CENTURION SUPER 132	15 - 60	132	52"	155	60"	3-10	1-4	40	20	350	770
CENTURION SUPER 158	15 - 60	158	62"	195	72"	3-10	1-4	48	24	372	819

cm	106	132	158
A	65	65	65
B	55	81	107
C	120	150	180
D	140	140	140
E	153	177	201
H	110	120	130
G	110	130	150
L	100	100	100

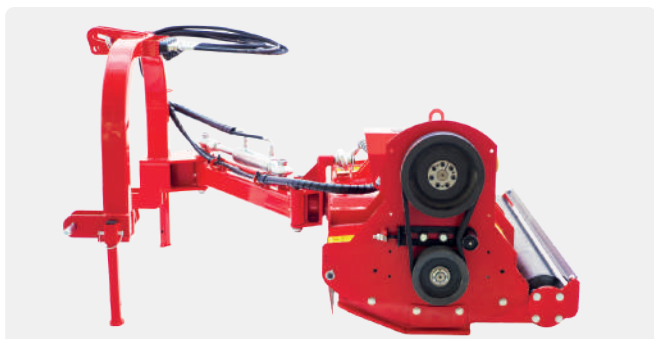
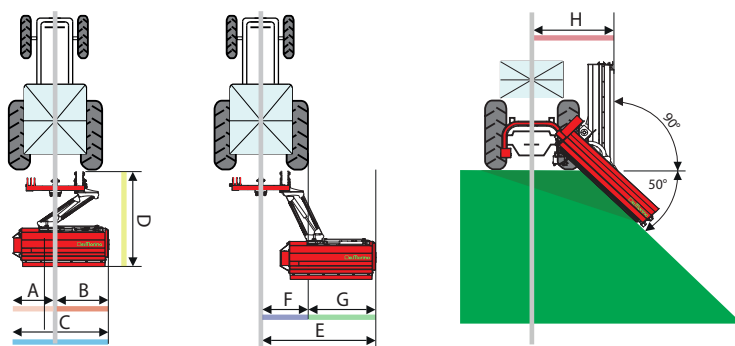

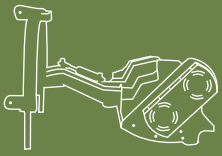

- 4 attacchi rapidi idraulici
- 4 quick hydraulic connections
- 4 raccords rapides hydrauliques

- Riduttore in ghisa 540 g/min con disp. di ruota libera
- 540 rpm cast iron gearbox with free wheel device
- Boitier en fonte 540 t/min avec roue libre intergrée

- Trasmissione a 2 cinghie con tenditore a vite
- Three belts transmission with screw tensioner
- Trasmission par 3 courroies ventilées par tendeur a vis réglable

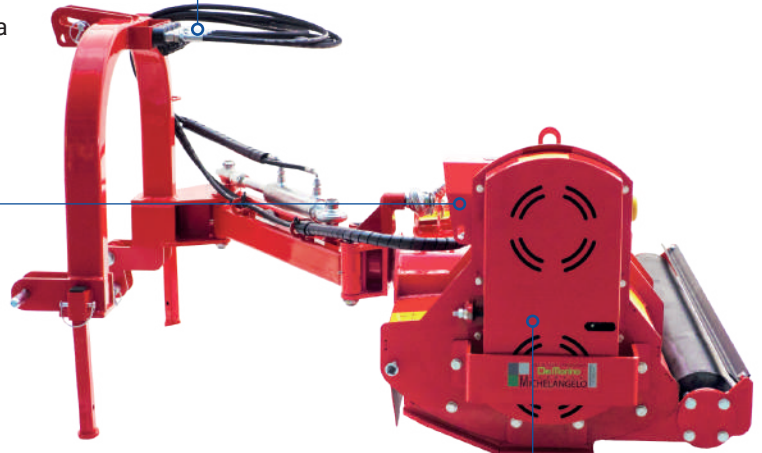

Rotazione idraulica +90° -45°

Hydraulic rotation +90° -45°

Rotation Hydrauliques +90° -45°



Sistema antiurto

Antishock system

systeme antishock