



**USA
PRICE LIST
2026**

*Effective October 1st, 2025 and supersedes all previous pricing
PRICES SUBJECT TO CHANGE WITHOUT PRIOR NOTICE*

2026 US Dealer Price List

Quick Reference Guide

B58 Forage Boxes



Numerous Configurations Available

- Available in 19', 22' & 25' models. Front unloading, rear unloading and combo box configurations means there is a box to suit any type of situation on any type of farm.

No Weld Construction

- No weld construction means a box that stands up to the flex and torque produced by today's high capacity harvesters and high velocity tractors.
- Tie rods for prolonged longevity, can be retightened over time to maintain structural integrity.

Quick and Safe Unloading

- With a standard hydraulic rear unload speed of 19 ft/min, unload into bunk silos as fast as a dump trailer but more safely.

Tons of Options

- In-cab hydraulic controls for front unloading and combo boxes. Unload and get back out to the field without ever leaving the cab.
- Receiver kits for top loading and High Dump boxes.
- 18" conveyor extensions for increased maneuverability around the silo.
- 18" side extensions available.
- Optional roof.

Truck, Trailer or Wagon Mounted

- Truck mounted kit. *(Optional)*

2026 US Dealer Price List

B58 FORAGE BOX

Standard Equipment:

- Oil bath gearbox for beaters and cross conveyor drives.
- Heavy-duty bronze gear reducer driving main apron with variable speed belt drive.
- Operator station located near discharge station.
- Independent feathering clutch for cross conveyor and safety release.
- Three 18” diameter, uniquely designed beaters, providing uniform material discharge.
- CA-500 roller chain for 22” wide conveyor.
- Uniquely constructed, completely bolted structure made from high strength steel with saddles & wear plates, tie down chains, galvanized aluminum (Galvalume™) steel sides & rear door.
- All bolted steel side structure with unique transversal tie rod from post to post.
- Section assembly of roof.
- Transport lights.
- Clean out panel for cross conveyor.
- Left or right discharge configuration.
- Grease hoses for ease of maintenance of beater bushings.
- Tie down chains. Safety cables (emergency stop) on both sides.

B58 Specifications			
Unloading Configuration.	Combo Box & Rear Unload (22’ & 25’ Only). Front Unload (All Sizes).		
Box Size, Floor Length (ft.)	19	22	25
Capacity with Roof, ASAE S238.1 (cu. ft.)	1010	1167	1325
Capacity less Roof, ASAE S238.1 (cu. ft.)	870	1010	1150
Inside Width. (in.)	88		
Inside Height. (in.)	91		
Overall Height – Incl. Structure. (in.)	114		
Overall Length. (in.)	266	308	344
Overall Width. (in.)	107		
Weight (lbs.) Front Unloading Box.	4950	5400	5850
Main Apron Pintle Chain. 4 per Box @ 15000 lb. min. pull each.	#667X	#667X	#667X
Cross Feed Delivery.	Left or Right		
Cross Feed Apron Width. (in)	22		
Cross Feed Conveyor Apron.	CA550 roller chain with welded slats		
Cross Feed Cleanout Door.	Yes		
Cross Feed Conveyor Extension. (in) - Optional	18 (Retractable)		
Post Spacing. (in)	36	18	18
Three Unloading Metering Beatere.	18” Diameter		
Safety Clutch.	Quick Release Push Bar at Front, Cable on Either Side – Quick Re-Engage.		
Power Source – Front Unload.	540 RPM PTO Drive OR Optional Hydraulic Drive		

2026 US Dealer Price List

Box – Front Unloading		
ITEM	DESCRIPTION	SUGGESTED LIST PRICE (USD)
B5819LFAX B5819RFAX	19' Box, Font Unloading. - Left Discharge. - Right Discharge. *** Early Order Booking Only***	\$33,600.00
B5822LFA B5822RFA	22' Box, Font Unloading. (With receiver box kit) - Left Discharge. - Right Discharge. *** Early Order Booking Only***	\$37,220.00

Box - Rear Unloading		
ITEM	DESCRIPTION	SUGGESTED LIST PRICE (USD)
B5822RUH	22' Box Rear Unloading. (With receiver box kit)	\$23,575.00
B5825RUH	25' Box Rear Unloading. (With receiver box kit)	\$27,775.00

2026 US Dealer Price List

Box – Front & Rear Unloading 'Combo'		
ITEM	DESCRIPTION	SUGGESTED LIST PRICE (USD)
B5822LPH B5822RPH	22' Box, Front and Rear Unloading. (With receiver box kit) - Left Discharge. - Right Discharge. *** Early Order Booking Only***	\$44,365.00
B5825LPH B5825RPH	25' Box, Front and Rear Unloading. (With receiver box kit) - Left Discharge. - Right Discharge. *** Early Order Booking Only***	\$48,100.00

Optional Truck Mounting		
ITEM	DESCRIPTION	SUGGESTED LIST PRICE (USD)
K31149	Truck Mount Reinforcement Kit - 22' Box.	\$1,680.00
K31150	Truck Mount Reinforcement Kit - 25' Box.	\$1,990.00
	Truck Mount Reinforcement Kit & Frame Narrowing - <i>factory installed.</i>	\$800.00 <i>(net price)</i>

2026 US Dealer Price List

Optional Equipment		
ITEM	DESCRIPTION	SUGGESTED LIST PRICE (USD)
K23556	Coiled Cable For Transport Light. (Use with Wagon)	\$245.00
K28409	Coiled Cable For Transport Light. (Use with Trailer)	\$260.00
	18" Fold-Up Cross Conveyor Extension.	
K23587 K23588	- Left Unloading. - Right Unloading.	\$1,265.00
	Conveyor Extension – <i>factory installed</i>	\$550.00 <i>(net price)</i>
K28435	18" Side Extension Kit for 22' Box. <i>(Per Side)</i>	\$1,440.00
K28436	18" Side Extension Kit for 25' Box. <i>(Per Side)</i>	\$1,825.00
K29065	18" Arch Extension Kit for Front or Rear of Box.	\$610.00
	18" Side Extension Kit - <i>factory installed. (Per Side)</i>	\$420.00 <i>(net price)</i>
K28875	Front Arch for Side Extension. (When equipped with 1 side only)	\$260.00
K28873	Front Arch for Side Extension. (When equipped with 2 sides)	\$340.00
K26920	4 th Beater Kit	\$2,015.00
	4 th beater kit – <i>factory installed (Must be ordered with side extensions)</i>	\$420.00 <i>(net price)</i>
K30236	Gate Delay Kit	\$1,155.00
	Gate Delay Kit – <i>factory installed</i>	\$340.00 <i>(net price)</i>

2026 US Dealer Price List

Optional Hydraulic Equipment		
ITEM	DESCRIPTION	SUGGESTED LIST PRICE (USD)
K23960L	Hydraulic Drive LH Unloading Box.	\$1,690.00
K23960R	Hydraulic Drive RH Unloading Box.	
	Hydraulic Drive. <i>(Factory Installation)</i>	\$315.00 <i>(net price)</i>
K28251	Cab Controlled Hydraulic Kit (Raise & Lower) for 18" Cross Conveyer Extension. <i>(LH Discharge)</i>	\$1,100.00
K28250	Cab Controlled Hydraulic Kit (Raise & Lower) for 18" Cross Conveyer Extension. <i>(RH Discharge)</i>	
	Cross Conveyer Extension. <i>(Factory Installation)</i>	\$260.00 <i>(net price)</i>
K28381	Cab Controlled Hydraulic Kit for 18" Cross Conveyer, Beaters & Apron Floor. <i>(Left Unloading)</i>	\$1,365.00
K28380	Cab Controlled Hydraulic Kit for 18" Cross Conveyer, Beaters & Apron Floor. <i>(Right Unloading)</i>	
	Hydraulic Cross Conveyer, Beaters & Apron Floor Drive. <i>(Factory Installation)</i>	\$315.00 <i>(net price)</i>
K28357	Hydraulic Blocking Safety Valve Kit.	\$360.00
K28356	<i>(Mandatory if purchased with K 28250/1 & K 28380/1)</i>	
	Safety Valve. <i>(Factory Installation)</i>	\$185.00 <i>(net price)</i>

2026 US Dealer Price List

Roof (Dealer Installed)				
ITEM	DESCRIPTION			SUGGESTED LIST PRICE (USD)
	Box Format	Roof Height	Roof Length	
K23577	Front Discharge	22"	19'	\$2,400.00
K23579	Front Discharge	22"	22'	\$2,660.00
K27941	Front Discharge	22"	25'	\$3,060.00
K24582	COMBO Front/Rear Discharge	22"	22'	\$2,125.00
K27942	COMBO Front/Rear Discharge	22"	25'	\$2,385.00
	Roof – <i>(Factory Installed)</i>			\$660.00 <i>(net price)</i>
K23961	Front Arch Brace. (Mandatory with boxes ordered without roof)			\$445.00

2026 US Dealer Price List

Quick Reference Guide

860 & 860HO Forage Blowers

Two Different Models:

- 540 RPM direct drive (860)
- 1000 RPM (860HO)
 - 650RPM at fan increases blowing capacity by 20%

8 Blades are Better than 4!

- The eight blade 860HO blower turning at 650 rpm generates 30% more blade passes per minute than a four blade blower turning at 1000 rpm.
- An eight blade blower distributes wear more evenly than a one with four blades so you are not replacing wear parts as often.
- Eight blades are easier to balance than four, resulting in less vibration.
- With eight blades, there is less crop pickup up per blade but more crop over all, with less torque spikes and less vibration.
- A high inertia in the Dion 860 & 860HO reduces torque spikes on tractor, resulting in less chances of clogging from a drop in PTO rpm and is less demanding on the tractor.

Largest Auger on the Market

- The 14"Ø (14" pitch) feeding auger is the largest on the market.
- Augers are more effective and energy efficient than spinners for feeding.

Reduce Wear on Your Tractor

- All Dion blowers come standard with an overrunning clutch. This protects the PTO brake of the tractor.

Heavy Duty Construction

- The 860 & 860HO are equipped with heavy duty cast iron pulleys and completely double belted.
- All bearings are high quality NTN (no cheap Chinese bearings in the unit).
- No rotation disk inside the fan. The shape of the paddles eliminates the need for this.
- Large frontal adjustment / cleanout door.
- Heavy Duty angle iron blower arms.
- Heavy Duty PTO.
- Hydraulically Adjustable Heavy-Duty Wheels & Tires for ease of adjustment & transport.

2026 US Dealer Price List

860 FORAGE BLOWER

- Legendary DION HD Forage Blowers.
 - 59" Diameter Fan with 8 HD Blades.
 - Double Belt Driven. Cast Iron Pulleys.
 - Over Running Clutch. Heavy Duty NTN Bearings.
 - Double water inlets (Band & Auger), Choice of Driveline & Auger.
 - Hydraulically Adjustable HD Wheels & Tires.
- *** Minimum recommended HP required: 1HP per foot of silo. *****

- 14"Ø (14" pitch) feeding auger.
 - More efficient than our previous 14"Ø (10" pitch) auger and equal capacity of our 16"Ø (16" pitch) auger.
- Discharge spout thickness increased to 11 ga. (previously 14 ga.) for better wear characteristics.
- Blower band now in 2 sections with reversable wear plate section made from Hardox 450.
- Large vertical hopper extension.
 - Offers better wind protection and accepts silage from boxes sitting on higher trailers.

ARTICLE	DESCRIPTION		SUGGESTED LIST PRICE (USD)
	RPM	AUGER DIAMETER	
860	540	14"	\$21,115.00
860HO138	1000 (Fan @ 650 rpm) 1 3/8-21 Spline Yoke	14"	\$23,740.00
860HO134	1000 (Fan @ 650 rpm) 1 3/4-20 Spline Yoke	14"	\$23,900.00

2026 US Dealer Price List

Quick Reference Guide

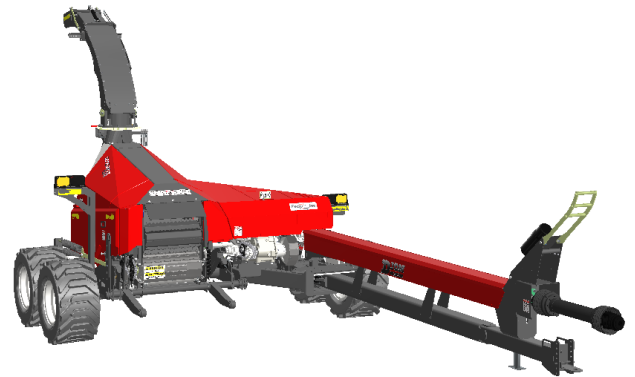

The next generation of Dion Harvesters!

Scorpion 300

- 300 hp rating
- Mechanical feedroll drive – 2 LOC ranges - 2 cutterhead options
- Electro-hydraulic controls – New control box

Common Standard features:

Industry Exclusive Straight Through Design

- The most energy efficient PTFH available.
- Crop is accelerating at each stage of the process.
- No energy is wasted by having to re-accelerate after changing directions unlike competing PTFHs using cross augers. The competition's crop changes direction multiple times in the chopping process, therefore wasting energy.

1033 RPM Cutting Cylinder Speed

- The cutting cylinder turns **1033 rpm** vs the closest competitor turning 850 rpm. This results in 21.5% more cuts/min & greater capacity.
- Industry exclusive, forward sharpening process requires less time, draws sharpening heat away from knife tip & provides optimal cutting edge shape.

Total Shear Technology (τστ) Kernel processor (KP)

- A **67% ratio** between the upper and lower processor rolls is the highest in the industry.
- Creates a higher feed value in the silage by opening up the kernels and increasing effective fiber.
- By using a high surface speed ratio rather than a large crushing force there is less wear on the high speed KP bearings.
- Roll gap adjustment is done by tightening or loosening just two bolts in mere seconds.
- Replaceable 45mm (~1.75") shafts and oversized, premium 45mm (~1.75") spherical roller bearings.
- 5 teeth/inch serrated processor rolls that are dynamically balanced.
- ¾" wall thickness with high hardness (55RC) heat treatment for longevity.
- Disabling the KP can be done in 30 minutes and with one single ¾" wrench. The top roll slides out of the harvester so the crop flow is always straight through.



2026 US Dealer Price List

Quick and Simple Daily Maintenance:

- **One side one bolt** shear bar adjustment: An industry exclusive. Shear bar is adjusted in seconds using just one (1) bolt.

STINGER spout option

All models “Stinger Ready”

- No modifications required
- Quick installation and conversion
- Dealer/field installed kit

Designed for Side Loading

- Reaches a maximum height of 19ft. (5.8m).
- 330° of rotation & enough horizontal reach to chop left, right or straight back.
- Wide angle day & night camera with 7” in-cab, color monitor is standard.

Electro-Hydraulic Controlled

- Electro Hydraulic controls for rotation, height and deflection are all integrated.

Integrated Suspension

- Hydraulic accumulator suspension creates a smooth ride in the field and on the road.
- No bulky supports to install.
- Folds down to less than 3m for road transport and storage with an incorporated ‘auto-lock’ system.

Heavy Duty

- Hardox and Domex abrasion resistant liners are accessible from the top for simple replacement.



2026 US Dealer Price List



High capacity base model

- Forage harvester rated for up to 300 pto hp.
-  Metal detector with self-calibrating **SMT** (*Smart Threshold Technology*).
- Heavy duty 1000 rpm drive line with hd gear box.
- 24" wide cutterhead, 22" diameter – **1033 rpm**.
- Cutter head shear bolt protected with over running clutch.
- Radial pin clutch for top and bottom feed rolls.
- Knife sharpener with 3" diameter stone. (cutter head is sharpened in forward direction)
- Electro-hydraulic functions:
 - F-N-R shifting
 - Spout (raise/lower)
 - Spout rotation & déeflector
 - Tongue swing
 - Header raise & lower
- Long tongue for dual wheel tractor.
- Quick, one side shear bar adjustment.
- Reversible tungsten carbide edge shear bar.
- Abrasion resistant blower housing.
- Replaceable spout liner. Made from ¼" *Hardox*.
- Adjustable axles height & tread width.
- Fixed wagon hitch.
- Adjustable attachment flotation height.
- Led transport lights.
- Tool box equipped with: safety glasses, drive chain for attachments, 3 loc sprockets & safety chain.
- Two processor rolls.
 - One 6" diameter and one 10" diameter.
 - The 67% speed difference shearing action between the processor rolls (**τστ**) uses less power than regular crushing action.
 - LHS removal of top roll for hay operation (≤ 30 mins & stores onboard).
 - Quick and easy adjustable roll spacing depending on crop condition.
 - Roll drive – 6 double AA V-belts.
 - 4 industrial high speed bearings.

2026 US Dealer Price List

DION Scorpion 300 Code Generator

S UU - VV WW X Y Z - A B C D E
 S 08 - 30 10 H D K - L 4F 20 T2 E

- S:** S = DION Base Unit
- UU:** 08 = DION 8 knives cutterhead
 12 = DION 12 knives cutterhead
- VV:** 30 = Mechanical Feedrolls Transmission
- WW:** 10 = 1000 : 1033 Cutterhead Speed
 80 = 1000 : 824 Cutterhead Speed
 54 = 540 : 824 Cutterhead Speed
- X:** H = LOC Range 12-18-24mm (0.46" - 0.71" - 0.94")
 L = LOC Range 9-14-18mm (0.36" - 0.55" - 0.71")
- Y:** D = Metal Detector
 X = No Metal Detector
- Z:** K = Kernel Processor
 F = No Kernel Processor
- A:** O = No Spout Extension
 M = Short Horizontal Extension 1.5m (5ft)
 L = Long Horizontal Extension 4.1m (13'8")
 Stinger
- B:** 2C = English Operator's Manual
 F = French Operator's Manual
- C:** S = Single Axle – Terra Rib Tire
 = Single Axle – Terra Trac Tire
 S3 = Single Axle – Dyno Rib Tire
 T1 = Tandem Axle – Terra Rib Tire
 T2 = Tandem Axle – Terra Trac Tire
- CC:** 06 = 1-3/8 – 6 spline
 (540 RPM model only)
 21 = 1-3/8 – 21 spline
 20 = 1-3/4 – 20 spline
- BB:** 2C = Category II Hitch (Clevis)
 3F = Category III Hitch (Flat Bar)
 3C = Category III Hitch (Clevis)
 4F = Category IV Hitch (Flat Bar)
 4C = Category IV Hitch (Clevis)

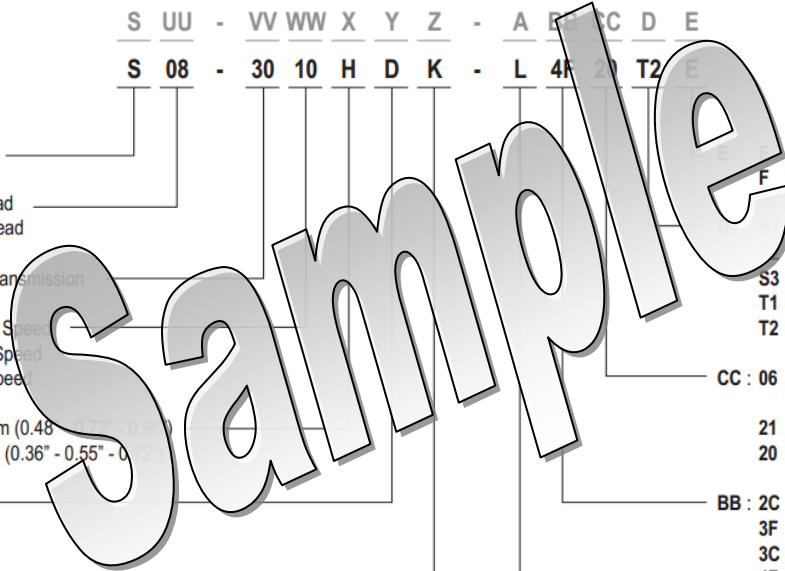

Ordering Code													
	1		2	3	4	5	6	-	7	8	9	10	11
S		-	30					-					





Fixed	DION SCORPION 300 Base Unit	List Price
S	= SCORPION 300 Base unit - 300HP	\$115,800.00
Pos. 1	Cutterhead Speed Selection	List Price
08	= 8 Knife Cutterhead	\$0.00
12	= 12 Knife Cutterhead <i>(Optional)</i>	\$2,300.00
Pos. 2	Feedroll Transmission Selection	List Price
30	= Mechanical F-N-R Transmission, Hydraulic Shift	\$0.00

2026 US Dealer Price List

Pos. 3	Cutterhead Speed Selection	List Price
10	= 1000 RPM PTO : 1033 RPM Cutterhead (Suggested hp range: up to 300)	\$0.00
80	= 1000 RPM PTO : 824 RPM Cutterhead (Suggested hp range: up to 145)	\$0.00
54	= 540 RPM PTO : 824 RPM Cutterhead (Suggested hp range: ≤ 120) (Special Order Only)	\$0.00
Pos. 4	Length of Cut Range	List Price
H	= LOC Range (8 Knives) 12-18-24 mm (0.47"-0.71"-0.93") LOC Range (12 Knives) 8-12-16 mm (0.31"-0.48"-0.62")	\$0.00
L	= LOC Range (8 Knives) 9-14-18 mm (0.36"-0.55"-0.71") LOC Range (12 Knives) 6-9-12 mm (0.24"-0.36"-0.48")	\$0.00
Pos. 5	Metal Detection System	List Price
D	= Metal Detector	\$0.00
X	= No Metal Detector (Special Order Only)	(-\$1,660.00)
Pos. 6	Kernel Processor	List Price
K	= Kernel Processor	\$0.00
F	= No Kernel Processor	(-\$9,275.00)
Pos. 7	Spout Selection	List Price
O	= Standard Spout	\$0.00
L	= STINGER Spout Option 4.1m (13'8") **Cannot be used with 800 RPM gearbox (80) or single wheels (S1, S2)**	\$8,395.00
Pos. 8	Tractor Hitch Selection	List Price
2C	= Category II Hitch (Clevis) - 1.2" Hitch Pin	\$0.00
3F	= Category III Hitch (Flat Bar) - 1.6" Hitch Pin	\$0.00
3C	= Category III Hitch (Clevis) - 1.6" Hitch Pin	\$0.00
4F	= Category IV Hitch (Flat Bar) - 2" Hitch Pin	\$0.00

2026 US Dealer Price List

Pos. 9	PTO Shaft Selection	List Price
06	= 1 $\frac{3}{8}$ - 6 spline (540 RPM model only)	\$0.00
21	= 1 $\frac{3}{8}$ - 21 spline	\$0.00
20	= 1 $\frac{3}{4}$ - 20 spline	\$0.00

Pos. 10	Axle & Wheel Selection	List Price
S1	Single Axle Terra Rib Tires 31X13.50-15 (2) <i>**Cannot be used with F61-120**</i> 	(-\$1,700.00)
S2	Single Axle Terra Trac Tires 31X15.50-15 (2) <i>**Cannot be used with F61-120**</i> 	(-\$1,100.00)
T1	Tandem Axle Terra Rib Tires 31X13.50-15 (4) 	\$0.00
T2	Tandem Axle Terra Trac Tires 31X15.50-15 (4) 	\$3,170.00

Pos. 11	Operator's Manual Language	List Price
E	= English Operator's Manual	\$0.00
F	= French Operator's Manual	\$0.00

2026 US Dealer Price List

Scorpion 300 - Optional Equipment		
ITEM	DESCRIPTION	SUGGESTED LIST PRICE (USD)
K32788	Spout LED Spot Light Kit <i>Already included in Stinger spout optional kit</i>	\$310.00
K31274	18" Vertical Extension **Caution** <i>Can <u>NOT</u> be used with STINGER spout.</i>	\$1,245.00
K31284	Stinger Extension Kit (Field Installed) <i>Includes 4.1m extension, camera, spout light & accumulator suspension system.</i>	\$9,600.00
K22004-6	6" Tractor Tongue Extension (Category II only)	\$425.00
K22004-8	8" Tractor Tongue Extension (Category II only)	\$425.00
K27700-6	6" Tractor Tongue Extension (Category III & IV only)	\$800.00
K27700-8	8" Tractor Tongue Extension (Category III & IV only)	\$800.00
K31275	Inoculant/Water Tank Kit (50 Gallons / 190 Liters) <i>Includes pump, filters and nozzle.</i>	\$3,100.00
K29276	Additional Water Tank Kit <i>Converts 50 Gallon kit to 100 Gallons (380 Liters)</i>	\$2,030.00
K31280	Hydraulic Attach-Matic™ Automatic Wagon Hitch (1" Pin)	\$2,195.00
K32445	Agri-Speed™ Hitch Conversion Kit. <i>(Convert your existing hitch setup to work seamlessly with the Scorpion 300)</i>	\$1,035.00
K32014	Friction Clutch Cutterhead Driveshaft <i>Replaces shearbolt cutterhead driveshaft, call for details.</i>	\$2,670.00
K32851	Kernel Processor (Field Installed)	\$15,120.00

2026 US Dealer Price List

Scorpion 300 - Optional Equipment (Cont'd)		
ITEM	DESCRIPTION	SUGGESTED LIST PRICE (USD)
K31673	<p>Wifi camera kit Includes 1 camera, 7in color monitor with power cables and antennas.</p> <p>Harvester is pre-wired with 12V power connectors for 1 camera on spout and 1 other camera at rear or side.</p> <p>Monitor mandatory for wifi connection – receiver module for tractor monitor display TBA.</p> <p>Already included in Stinger spout optional kit</p>	\$920.00
K31540	<p>Additional camera Unit Requires Camera kit K31673. Harvester pre-wired for 2 cameras, monitor support up to 4.</p>	\$785.00
K31288	<p>Remote Joystick Duplicates control box joystick (spout rotation and deflector) to remote location – 5 ft cable.</p>	\$475.00
K31286	<p>Converts LOC range 'H' to 'L' 8 Knives - 12-18-24 mm to 9-14-18 mm (0.47"-0.71"-0.93" to 0.36"-0.55"-0.71") 12 Knives - 8-12-16 mm to 6-9-12 mm (0.31"-0.48"-0.62" to 0.24"-0.36"-0.48")</p>	\$1,610.00
K31287	<p>Converts LOC range 'L' to 'H' 8 Knives - 9-14-18mm to 12-18-24mm (0.36"-0.55"-0.72" to 0.48"-0.72"-0.96") 12 Knives - 6-9-12 mm to 8-12-16 mm(0.24"-0.36"-0.48" to 0.31"-0.48"-0.62")</p>	\$1,610.00
K31205	<p>Battery Cable with Quick Connector & Fuse For tractors not equipped with in-cab 3 pin power connection.</p>	\$315.00
K31282	<p>10 Ft. Extension Cord for Control Box. For articulated tractors</p>	\$575.00

2026 US Dealer Price List

Quick Reference Guide

F71 Hay Pick-Up

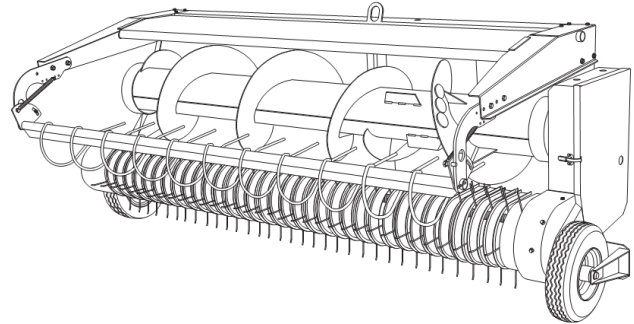

9 Ft (2.74m) Pickup

- 99 ¼" (2.52m) tine to tine width.
- 108" (2.74m) effective width.

5 Bar Pickup

- A 5 bar pickup reel in the F71 generates an even flow of material to the harvester.
- 34 tines/bar.
- Effective in from heavy to light windrows.
- Competitors only offer 4 bar pickup reels.

Large Auger

- 22" diameter auger for high capacity feeding.

Integrated Overload Protection

- Star Ratchet Clutch protects the unit from overfeeding.
- No shear bolts.

F46 Hay Pick-Up

7 Ft (2.13m) Pickup

- 75" (1.91m) tine to tine width.
- 84" (2.13m) effective width.

5 Bar Pickup

- A 5 bar pickup reel in the F46 generates an even flow of material to the harvester.
- 26 tines/bar.
- Effective in moderate & light windrows.
- Competitors only offer 4 bar pickup reels.

Large Auger

- 20" diameter auger for efficient feeding.

Integrated Overload Protection

- Star Ratchet Clutch protects the unit from overfeeding.
- No shear bolts.

2026 US Dealer Price List

FORAGE HARVESTER HEADS

Hay Heads

ITEM	DESCRIPTION	SUGGESTED LIST PRICE (USD)
F46-84R	Hay Pick-Up Attachment, 7ft Wide with Gauge Wheels.	\$17,735.00
F71-108R	Hay Pick-Up Attachment, 9ft Wide with Gauge Wheels.	\$20,755.00

2026 US Dealer Price List

Quick Reference Guide

Rotary Corn Heads

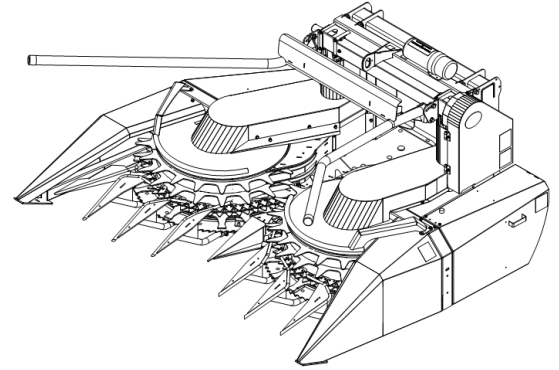

Available in 2 different sizes

- Dion-Ag offers the **largest** pull-type corn head on the market. The F61-120" (4 row equivalent @ 30" rows). Also available for self-propelled harvesters as the F63-120".
- Dion-Ag also manufactures the F64 - 90" (3 row equivalent @ 30" rows) corn head.
- Dion-Ag also offers interchangeable, "plug and play" adapter kits available for most brands of pull-type harvesters.

Row independent

- Harvest with or against the direction of planting. Harvest any width of rows and twin planted corn without any modifications or adjustments.

Even Feeding & Energy Efficient

- Dion-Ag's patented conveyor chain system provides a consistent flow of crop to the harvester while requiring 30% less energy to run than a conventional row head.
- No auger design.
- Feeds the stalks perpendicular to cutting cylinder for consistent LOC and best chop quality.

Low Maintenance

- Low maintenance machine, daily lubrication and a simple chain tension verification is all that's needed.
- Knives are tungsten coated for extended life & create a self-sharpening wear pattern.

2026 US Dealer Price List

Rotary Corn Heads		
F64 - 90" (2.25 meters) 3 Row Equivalent @ 30" Rows		
F64-90R	90" Row Independent Corn Head (2,25 meters)	\$30,750.00
ITEM	BASE UNIT <i>Must be ordered with one Adaptor Kit below</i>	SUGGESTED LIST PRICE (USD)
K26247	DION Scorpion 300 & DION F41	\$2,295.00
K26463	DION 1224, Heston 7500 & New Idea 1500	\$2,640.00
K27494	Adaptor Kit for NH 900	\$2,640.00
K27500	New Holland FP230, FP240 & Case IH FHX300	\$2,640.00
K26234	Gehl 1065/75/85 1265/75/85	\$3,220.00
K27144	JD 3965/75	\$2,640.00

Optional Equipment		
ITEM	DESCRIPTION	SUGGESTED LIST PRICE (USD)
K26898	Single Rotary Lift Kit (Downed Corn)	\$2,910.00

2026 US Dealer Price List

Rotary Corn Heads		
F61 - 120" (3 meters) 4 Row Equivalent @ 30" Rows		
F61-120R	120" Row Independent Corn Head	\$38,250.00
ITEM	BASE UNIT <i>Must be ordered with one Adaptor Kit below</i>	SUGGESTED LIST PRICE (USD)
K25762	DION Scorpion 300 & DION F41	\$1,665.00
K26190	Gehl 1265/75/85	\$3,220.00
K27605	New Holland FP230, FP240 & Case IH FHX300	\$3,220.00

Optional Equipment		
ITEM	DESCRIPTION	SUGGESTED LIST PRICE (USD)
K26898	Single Rotary Lift Kit. (Downed Corn)	\$2,910.00

2026 US Dealer Price List

Rotary Corn Heads (Self-Propelled)		
F63 - 120" (3 meters) 4 Row Equivalent @ 30" Rows (Self-Propelled)		
F63-120	120" Row Independent Corn Head. GRAY (3 meters) (SELF-PROPRELLED)	\$43,770.00
Produced for Early Order Booking ONLY		
ITEM	BASE UNIT <i>Must be ordered with one Adaptor Kit below</i>	SUGGESTED LIST PRICE (USD)
K26665	5000 Series John Deere	\$4,635.00
K27515	6000 & 7000 Series John Deere	\$5,100.00
K26780	1900 & 2100 Series New Holland	\$5,100.00
K27516	FX Series New Holland	\$5,100.00

Optional Equipment		
ITEM	DESCRIPTION	SUGGESTED LIST PRICE (USD)
K26971	Double Rotary Lift Kit. (Downed Corn)	\$5,690.00

2026 US Dealer Price List

PRINTED MATERIAL

<i>Warranty Forms</i>		
ITEM	DESCRIPTION	NET PRICE (USD)
WC1013-10	Warranty Forms. (10/pkg)	\$10.00 <i>(net price)</i>

<i>Brochures</i>		
ITEM	DESCRIPTION	NET PRICE (USD)
V01E0119	12 Page, Color, English Brochure. (10/ pkg)	\$10.00 <i>(net price)</i>
V01F0119	12 Page, Color, French Brochure. (10/ pkg)	\$10.00 <i>(net price)</i>