



LIVING COUNTRY

EQUIPMENT FOR RURAL PROPERTY CARE



7 YEAR WARRANTY

NEW ARRIVALS FOR 2024!



EXTREME DUTY

BRUSH CUTTER

- 78" Brush Cutter - Skid Steer attachment
- 10" cut capacity
- Heavy duty 1" cutting bar; 4 cutting blades

See Page 27



REDESIGNED PULL TYPE SNOW BLOWER

- Full New High Performance Design
- Cleans Tight to the Garage Door
- 5 Blade Impeller
- Multi-Hinged Deflector

See Page 5



COMMERCIAL SNOW BLOWER

- Hydraulic Chute Rotator
- Hydraulic 2-Stage Deflector
- Dual Augers with Ribbon Flighting

See Page 16



SIDEWALK SNOWTHROWER

- Carbide Skid Shoes & Side Plates
- Oil Bath Chain
- Spring Loaded Carbide Side Plates
- Frame Linkage
- V-Trip Cutting Edge

See Page 15



UTV SNOW THROWER

- Fits Most Leading UTV Models
- 14 Horsepower Vanguard Engine
- 54 Inch Cutting Width
- Universal Mount Plate

See Page 14



TRAILER BACKHOE

- 360 degree rotation
- 4' 11" working depth
- 1764 lbs (800kg) digging force
- Towable design

See Page 49



12' & 14' XD GRADER BLADES

- Up to 14' grading path
- For tractors up to 250 HP
- Hydraulic cylinders control the blade angle, blade tilt and offset of the arm

See Page 35

TABLE OF CONTENTS



**3PH Mount
Snowblowers**

Page 01



**Pull Type
Snowblowers**

Page 05



**Skidsteer
Snowblowers**

Page 09



**Loader Mounts &
Power Packs**

Page 11



**Self Powered
Snow Throwers**

Page 13



**Commercial
Snowblowers**

Page 15



**3PH
Rotary Cutters**

Page 19



**Rotary Cutters -
Wing**

Page 25



**Skidsteer
Rotary Cutters**

Page 26



**Extreme Duty
Brush Cutters**

Page 27



**Finishing
Mowers**

Page 29



**Axis
Tool Arm**

Page 30



**Trail/UTV
Mowers**

Page 31



**Lawn
Sweepers**

Page 32



**Grader
Blades**

Page 33



**3PH Box
Blades**

Page 36



**Land
Levelers**

Page 37



**Grader
Levelers**

Page 39



**Land
Planes**

Page 41



**Landscape
Rakes**

Page 42



Cultivators

Page 42



**Track
Curry**

Page 43



**Rotary
Tillers**

Page 45



**Garden
Hillers**

Page 47



**Dump
Boxes**

Page 48



**Weight
Boxes**

Page 48



**Trailer
Backhoe**

Page 49



**Gravity
Boxes**

Page 51



Interseeder

Page 55



**Implement
Caddy**

Page 56

Single Auger Snowblowers



SPECIFICATIONS

Models	SB48	SB54	SB60
HP (Rec.)	12 HP	15 HP	20 HP
Cutting Width	48"	54"	60"
Cutting Edge	¼ x 1-½"	3/8 x 1"	3/8 x 1"
Auger Diam.	12"	14"	14"
Fan Diam.	19"	21"	21"
Chute Diam.	7"	8"	8"
Chute Rotation (Man/Hyd)		Select Option	
Chute Deflector	Manual	Manual Standard/ Hydraulic Option (see pg. 18)	
Main Body Height	22.5"	25"	25"
3PH Mount	Cat. 1	Cat. 1	Cat. 1
Weight (LBS.)	266	366	396
List Price (manual rotator)	Call for Pricing	Call for Pricing	Call for Pricing
with Hydraulic Rotator	Call for Pricing	Call for Pricing	Call for Pricing
with Electric Rotator	Call for Pricing	Call for Pricing	Call for Pricing



FEATURES

- 7 year limited warranty
- High tensile steel fighting
- 3PH quick attach compatible
- 5 blade fan/impeller
- SB48, SB54, and SB60 comes standard with manual rotators
- Manual chute deflector

OPTIONS

- Hydraulic rotators (all models)
- Manual rotators optional on all models
- Hydraulic chute deflector

WING KITS

- Fits SB54, SB60, SB68, and SB72
- 18" tall. Made with 10 gauge steel
- Increases path 2" per side



**NEW
PRODUCT**

Part #	List Price
55399	Call for pricing

SPECIFICATIONS

Models	SB68	SB72	SB78	SB87	SB97
HP (Rec.)	30 HP	35 HP	50 HP	60 HP	75 HP
Cutting Width	68"	72"	78"	87"	97"
Cutting Edge	3/8 x 1	3/8 x 1	1/2 x 1-1/2	1/2 x 2	1/2 x 2
Auger Diam.	14"	14"	15"	19"	19"
Fan Diam.	21"	21"	23"	27"	27"
Chute Diam.	10"	10"	10"	12"	12"
Chute Rotation (Man/Hyd)	Select Option				
Chute Deflector	Manual Standard/ Hydraulic Option (see pg. 18)				
Main Body Height	25"	25"	29"	36"	36"
3PH Mount	Cat. 1	Cat. 1	Cat. 1 & 2	Cat. 2	Cat. 2
Weight (LBS.)	506	540	748	1,034	1,106

List Price (no rotator)	Call for Pricing	Call for Pricing	Call for Pricing	Call for Pricing	Call for Pricing
with Manual Rotator	Call for Pricing	Call for Pricing	Call for Pricing	Call for Pricing	Call for Pricing
with Hydraulic Rotator	Call for Pricing	Call for Pricing	Call for Pricing	Call for Pricing	Call for Pricing
with Electric Rotator	Call for Pricing	Call for Pricing	Call for Pricing	NA	NA

Double Auger Snowblowers



FEATURES

- 5 Blade impeller
- 7 year limited warranty
- High tensile steel lighting on top and bottom augers
- Cat. 2 - 3PH on model SB87D
- Cat. 2 & Cat. 3 on SB97D-SB120D
- Hydraulic chute rotator standard (SB97D - SB120D)
- Manual chute deflector on all models
- Skid shoes

OPTIONS

- Optional hydraulic chute deflector on all models
- Optional 1000 RPM adaptor (SB97D - SB120D)

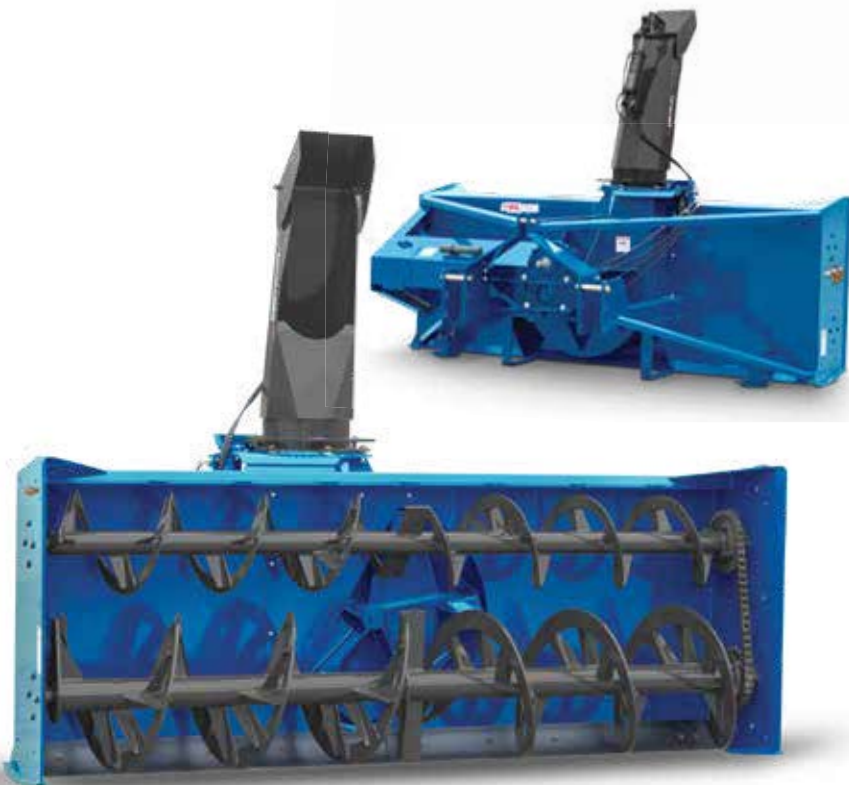

1000 RPM PTO KIT

Available for 97D, 108D and 120D models, this kit allows larger tractors to run at 1000 RPM PTO.

The 1000 RPM Kit also raises the input shaft to allow the PTO shaft to run at a lesser angle on larger tractors increasing the efficiency and life of the driveline components. The reduction box allows you to reverse the rotation so you can mount a regular snow blower to the front of a tractor.

PTO shaft not included.



Part #	List Price
SB97/1081000/SB1201000	Call for Pricing

SPECIFICATIONS

Models	SB87D	SB97D	SB108D	SB120D
Opt. 1000 RPM	-	Yes	Yes	Yes
HP (Rec.)	60 HP	100 HP	125 HP	200 HP
Cutting Width	87"	97"	108"	120"
Cutting Edge	½ x 2	½ X 6*	½ x 6*	½ x 6*
Auger Diam.	15" (x2)	15" (x1) 19" (x1)	15" (x1) 19" (x1)	15" (x1) 23" (x1)
Fan Diam.	27"	32"	32"	36"
Chute Diam.	12"	13"	13"	13"
Chute Rotation (Man/Hyd)	Selection Req. (Pg. 13)		Hydraulic Standard	
Chute Deflector (Man/Hyd)	Manual Deflector Standard/Hydraulic Option Pg.18			
Main Body Height	36"	43"	43"	47"
3PH Mount	Cat. 2	Cat. 2 & 3	Cat. 2 & 3	Cat. 2 & 3
Weight (LBS.)	1,161	1,900	1,980	3,010
Tube	3 ½" OD	4 ½" OD HEAVY WALL	4 ½" OD HEAVY WALL	4 ½" OD HEAVY WALL
Flighting	5/16 x 2 ¼	5/16 x 2-¼	5/16 x 2-¼	½ x 3
Roller Chain	#60 Heavy	#80	#80	#100
Fan Depth	10"	12"	12"	12"
Auger Drive Shaft	1 ¼"	1-¾"	1-¾"	1-¾"
Fan Output Shaft	40mm	2"	2"	2 ½"

List Price	Call for Pricing	SB97D	Call for Pricing	SB108D	Call for Pricing	SB120D	Call for Pricing
		SB97D 175	Call for Pricing	SB108D175	Call for Pricing	SB120DF1.75	Call for Pricing
		SB97DF1.75	Call for Pricing	SB108DF1.75	Call for Pricing	SB120DF	Call for Pricing
		SB97DF	Call for Pricing	SB108DF	Call for Pricing	SB120DF Truck	Call for Pricing

Pull Type Snowblowers - Performance Series

**NEW
PRODUCT**



MK Martin has completely redesigned the Pull Type Tractor Snowblower. Most notably with the redesign, the new Pull Type blower now cleans tight to the garage door, with no need for an additional back drag system. Connecting to your tractor's 3PH, the inverted snowblower allows you to drive straight forward pulling the blower instead of backing into the snow. Easier on your neck, the pull type blower is ideal for quickly clearing driveways and laneways.

TIVAR WEAR PARTS

Tivar is a wear resistant plastic that replaces steel cutting edges and bolts onto the skid shoes.

Optional on Pull Type models, the tivar is gentler when clearing, ideal for interlocking brick and decorative stone.



Skid Shoe

Cutting Edge

Part #	Tivar Kit
SB54PTTK	Cutting Edge & Skid Shoes
SB60PTTK	Cutting Edge & Skid Shoes
SB68PTTK	Cutting Edge & Skid Shoes
SB72PTTK	Cutting Edge & Skid Shoes
SB78PTTK	Cutting Edge & Skid Shoes
SB87PTTK	Cutting Edge & Skid Shoes
SB97PTTK	Cutting Edge & Skid Shoes



FEATURES

- Cleans tight to the garage door
- 5 blade impeller
- 7 year limited warranty
- High tensile steel flighting
- Standard manual chute deflector (all)
- Multi-hinged deflector (SB68P/T – SB97P/T)
- Standard manual chute rotator (SB54PT & SB60PT)

OPTIONS

- Hydraulic, manual and electric chute rotators
- Hydraulic chute deflectors
- Tivar contact surfaces

SPECIFICATIONS

Models	SB54PT-P	SB60PT-P	SB68PT-P	SB72PT-P	SB78PT-P	SB87PT-P	SB97PT-P
HP (Rec.)	25 HP	25 HP	35 HP	35 HP	50 HP	60 HP	60 HP
Cutting Width	54"	60"	68"	72"	78"	87"	97"
Cutting Edge	Bolt On (½ x 4)						
Auger Diam.	14"	14"	14"	14"	15"	19"	19"
Fan Diam.	18"	18"	21"	21"	23"	27"	27"
Chute Diam.	8"	8"	10"	10"	10"	12"	12"
Chute Rotation	Must select either Manual (opt.) or Hydraulic (opt.) or Electric (opt.)						
Chute Deflector	Manual Std./Opt. 6" cyl.			Manual Std./Opt. 8" cyl.			
Double Hood Deflector	N/A	N/A	Std.	Std.	Std.	Std.	Std.
Main Body Height	23"	23"	23"	23"	26"	28"	28"
3PH Mount	Cat. 1	Cat. 1	Cat. 1	Cat. 1	Cat. 1 & 2	Cat. 2	Cat. 2
Weight (LBS.)	462	495	671	685	900	1,175	1,260
Tube Size	2 3/8" OD	2 3/8" OD	2 3/8" OD	2 3/8" OD	3 1/2" OD	3 1/2" OD	3 1/2" OD
Flighting Size	¼ x 2 ¼	¼ x 2 ¼	¼ x 2 ¼	¼ x 2 ¼	¼ x 2 ¼	5/16 x 2 ¼	5/16 x 2 ¼
Roller Chain Drive	# 50	# 50	# 60 Heavy	# 60 Heavy	# 60 Heavy	# 60 Heavy	# 60 Heavy
Fan Depth	5"	5"	7"	7"	8"	10"	10"
Blades Per Fan	5	5	5	5	5	5	5
Auger Drive Shaft Size	1"	1"	1 ¼"	1 ¼"	1 ¼"	1 ¼"	1 ¼"
Fan Output Shaft Size	1 3/8"	1 3/8"	1 3/8"	1 3/8"	40mm	40mm	40mm

Pull Type Snowblowers



SPECIFICATIONS

Models	SB54 P/T	SB60 P/T	SB68 P/T	SB72 P/T	SB78 P/T	SB87 P/T	SB97 P/T
HP (Rec.)	25 HP	25 HP	35 HP	35 HP	50 HP	60 HP	60 HP
Cutting Width	54"	60"	68"	72"	78"	87"	97"
Cutting Edge	Bolt On (1/2 x 4)						
Auger Diam.	14"	14"	14"	14"	15"	19"	19"
Fan Diam.	18"	18"	21"	21"	23"	27"	27"
Chute Diam.	8"	8"	10"	10"	10"	12"	12"
Chute Rotation	Must select either Manual (opt.) or Hydraulic (opt.) or Electric (opt.)						
Chute Deflector	Manual Std./Opt. 6" cyl.			Manual Std./Opt. 8" cyl.			
Double Hood Deflector	N/A	N/A	Std.	Std.	Std.	Std.	Std.
Main Body Height	25"	25"	25"	25"	28"	32-1/2"	32-1/2"
3PH Mount	Cat. 1	Cat. 1	Cat. 1	Cat. 1	Cat. 1 & 2	Cat. 2	Cat. 2
Weight (LBS.)	462	495	671	685	900	1,175	1,225
Tube Size	2 3/8" OD	2 3/8" OD	2 3/8" OD	2 3/8" OD	3 1/2" OD	3 1/2" OD	3 1/2" OD
Flighting Size	1/4 x 2 1/4	1/4 x 2 1/4	1/4 x 2 1/4	1/4 x 2 1/4	1/4 x 2 1/4	5/16 x 2 1/4	5/16 x 2 1/4
Roller Chain Drive	# 50	# 50	# 60 Heavy	# 60 Heavy	# 60 Heavy	# 60 Heavy	# 60 Heavy
Fan Depth	5"	5"	7"	7"	8"	10"	10"
Blades Per Fan	5	5	5	5	5	5	5
Auger Drive Shaft Size	1"	1"	1 1/4"	1 1/4"	1 1/4"	1 1/4"	1 1/4"
Fan Output Shaft Size	1 3/8"	1 3/8"	1 3/8"	1 3/8"	40mm	40mm	40mm
List Price (no rotator)	Call for Pricing	Call for Pricing	Call for Pricing	Call for Pricing	Call for Pricing	Call for Pricing	Call for Pricing
with Manual Rotator	N/A	N/A	Call for Pricing	Call for Pricing	Call for Pricing	Call for Pricing	Call for Pricing
with Hydraulic Rotator	Call for Pricing	Call for Pricing	Call for Pricing	Call for Pricing	Call for Pricing	Call for Pricing	Call for Pricing
with Electric Rotator	Call for Pricing	Call for Pricing	Call for Pricing	Call for Pricing	Call for Pricing	Call for Pricing	Call for Pricing



FEATURES

- 5 blade impeller
- 7 year limited warranty
- High tensile steel flighting
- Standard manual chute deflector (all)
- Multi-hinged deflector (SB68P/T – SB97P/T)
- Standard manual chute rotator (SB54PT & SB60PT)

OPTIONS

- Hydraulic, manual and electric chute rotators
- Hydraulic chute deflectors
- Back drag (manual or hydraulic)
- Tivar contact surfaces

BACK DRAG

Optional back drags are manual chain adjustment, and can be upgraded to a hydraulic option for 68" and wider models.



TIVAR WEAR PARTS

Tivar is a wear resistant plastic that replaces steel cutting edges and bolts onto the skid shoes.

Optional on Pull Type models, the tivar is gentler when clearing, ideal for interlocking brick and decorative stone.



Skid Shoe

Cutting Edge

Back Drag	Lift Type	List Price
SB54PTRB	Man.	Call for Pricing
SB60PTRB	Man.	Call for Pricing
SB68PTRB17	Man. / Hyd.	Call for Pricing
SB72PTRB	Man. / Hyd.	Call for Pricing
SB78PTRB17	Man. / Hyd.	Call for Pricing
SB87PTRB17	Man. / Hyd.	Call for Pricing
SB97PTRB	Man. / Hyd.	Call for Pricing
Optional Hydraulic Kit (fits SB68PT - SB97PT)		
SBPTRBH17		Call for Pricing

Part #	Tivar Kit	List Price
SB54PTTK	Cutting Edge & Skid Shoes	Call for Pricing
SB60PTTK	Cutting Edge & Skid Shoes	Call for Pricing
SB68PTTK	Cutting Edge & Skid Shoes	Call for Pricing
SB72PTTK	Cutting Edge & Skid Shoes	Call for Pricing
SB78PTTK	Cutting Edge & Skid Shoes	Call for Pricing
SB87PTTK	Cutting Edge & Skid Shoes	Call for Pricing
SB97PTTK	Cutting Edge & Skid Shoes	Call for Pricing

Back Drag Part #	Tivar Kit	List Price
SB54PTBDBTK	Back Drag	Call for Pricing
SB60PTBDBTK	Back Drag	Call for Pricing
SB68PTBDBTK	Back Drag	Call for Pricing
SB72PTBDBTK	Back Drag	Call for Pricing
SB78PTBDBTK	Back Drag	Call for Pricing
SB87PTBDBTK	Back Drag	Call for Pricing
SB97PTBDBTK	Back Drag	Call for Pricing

Skidsteer Snowblowers

**NEW
PRODUCT**

M METEOR



FEATURES

- Adjustable blower fan tolerance for increased performance
- Auger has new teeth
- New curved edit chute for a more direct stream
- 5 blade impeller
- Direct fan drive mounted
- Up To 4439 ft/min fan tip speed
- Pivoting hitch plate
- Hitch plate height adjustable
- Solid side plate construction for added strength and rigidity
- Offset chute for better operator vision
- Hydraulic line check valve allow overrun and prevents reverse rotation
- Solenoid valve feature allows for use of hydraulic rotator motor and hydraulic deflector

OPTIONS

- Hydraulic chute deflector
- Optional wiring kit adapters for skid loader control integration
- Optional multi hinge deflector
- Optional poly edge for skid shoes

SPECIFICATIONS

Models	SSB62	SSB66	SSB76	SSB86	SSB96
Cutting Edge (Bolt-On)	½ x 4	½ x 4	½ x 4	½ x 4	½ x 4
Cutting Width	62"	66"	76"	86"	96"
Auger Tube	3 ½" Round				
Auger Flighting	5/16 x 2 ¼				
Auger Diam.	19"				
GPM (min)	14	14	14	23	33
Mounting	Universal Skidsteer Attach				
Chute Rotation	Hydraulic				
Chute Diam.	10"				
Main Body Height	27 ½"				
Chute Deflector	Manual Std/Hydraulic Opt				
Fan Diam.	24"		26"		
Fan Depth	8"				
Weight (LBS.)	910	928	970	1000	1,085
List Price	SSB62HYD-A Call for Pricing	SSB66HYD-A Call for Pricing	SSB76HYD-A Call for Pricing	SSB86HYD-C Call for Pricing	SSB96HYD-D Call for Pricing
	SSB62HYD-B Call for Pricing	SSB66HYD-B Call for Pricing	SSB76HYD-B Call for Pricing	SSB86HYD-C+ Call for Pricing	
	SSB62HYD-B+ Call for Pricing	SSB66HYD-B+ Call for Pricing	SSB76HYD-B+ Call for Pricing	SSB86HYD-D Call for Pricing	
		SSB66HYD-C Call for Pricing	SSB76HYD-C Call for Pricing		
			SSB76HYD-C+ Call for Pricing		
			SSB76HYD-D Call for Pricing		

Flow Rates	HP*	Code
14-17 GPM	22	A
18-20 GPM	27	B
20-22 GPM	30	B+
23-26 GPM	35	C
27-33 GPM	43	C+
33-40 GPM	52	D

*HP calculated at 2500 PSI
Code "D" high flow package is recommended on the SSB 96.

HYDRAULIC DEFLECTOR KIT

Part #	Description	List Price
SSB75HD	Hydraulic Deflector Kit	Call for Pricing

WIRING KITS

Optional Wiring Kits	Description	List Price
SSBEWK 7-Bobcat	7 Pin Wire Kit	Call for Pricing
SSBEK 8Cat	8 pin wire kit	Call for Pricing
SSBEK 8 Terrex	8 Pin Wire Kit	Call for Pricing
SSBEK 14Gehl/Case/NH/JCB/Volvo	14 Pin Wire Kit	Call for Pricing
SSBEK 14JD	14 Pin Wire Kit	Call for Pricing
SSBEWK14 Kubota/Wacker Neuson	14 Pin Wire Kit	Call for Pricing

*Wacker Neuson standard & high flow

Loader Mount Snowblowers & Power Packs



SPECIFICATIONS

Models	SSB66	SSB76	SSB86
Cutting Edge (Bolt-On)	½ x 4	½ x 4	½ x 4
Cutting Width	66"	76"	86"
Auger Tube		3 ½" Round	
Auger Flighting		5/16 x 2 ¼	
Auger Diam.		19"	
GPM		30	
Mounting		Universal Skidsteer Attach	
Chute Rotation		Hydraulic	
Chute Diam.		10"	
Main Body Height		27 ½"	
Chute Deflector		Manual Std/Hydraulic Opt	
Fan Diam.	24"		26"
Fan Depth		8"	
Weight (LBS.)*	928	970	1000
List Price (blower only)	Call for Pricing	Call for Pricing	Call for Pricing
With SBLMPP-30	Call for Pricing	Call for Pricing	Call for Pricing
With SBLMPPCS-30	Call for Pricing	Call for Pricing	Call for Pricing

* Weight includes snowblower only.



FEATURES

- Hydraulic Chute Rotation
- Hydraulic Chute Deflector

Available with the following quick tach:
(Must be specified at time of order)

- Universal skidsteer
- Euro (ALO)
- JD 440/540 combination

POWER PACKS

- 3PH Mount PTO
- 30 Gal. Capacity
- 2,500 PSI at 30 Gallons per Minute
- SBLMPP-30 can be run for up to 2-hours before cool down is required



Models	SBLMPP-30	SBLMPPCS-30
Recommended HP	40-60HP	40-60HP
Capacity (gallons)	30	30
Flow Rate (PSI)	30 GPM/2500 PSI	30 GPM/2500 PSI
Mount	3PH	3PH
Weight	535 LBS.	575 LBS.
Height	48"	48"
Width	39"	39"
Depth	30"	32"
Max Operating Temp. (°C)	2° C	30° C
Max Operating Time (hours)	2 Hour Duty Cycle	Full Duty Cycle
Cooling System Included	No	Yes
List Price	Call for Pricing	Call for Pricing

Self Powered Snow Throwers



FEATURES

For tractors and compact skid loaders without hydraulic remotes, MK Martin offers our self powered snow thrower.

While being easy to attach with no drive lines or hoses to worry about, the engine belt drives the shaft which transfers power to the rotor by a roller chain.

These self powered snow throwers are ideal for moving snow quickly with precision in mind. The flared body opening helps to cut snow and direct to the efficient rotor assembly.

SPECIFICATIONS

Model	S1054E	S1060E
Cutting Width	47"	53"
Motor Type	Vanguard 14HP	Vanguard 14HP
Electric Start	12 Volt	12 Volt
Clutch	Electric (start/stop blower)	
Rotor	16" @ 750 RPM	
Hood Rotator	Electric	Electric
Hood Deflector	Manual	Manual
Cutting Edge	Bolt on 1/4" x 3-1/2"	
Overall Width	54"	60"
Overall Depth	36"	36"
Main Body Height	22.75"	22.75"
Weight	470 lbs.	545 lb.
List Price	Call for Pricing	Call for Pricing



WIRED REMOTE

The wired controller allows for remote engine start and shutdown. Oversized buttons allows operators to make quick and accurate adjustment of the chute rotation.





FEATURES

**NEW
PRODUCT**

- Design to Fit Most Leading UTV Models
- 14 Horsepower Vanguard Engine
- 54 Inch Cutting Width
- Built to the Same Standard as Meteor Snowblowers
- Universal Mount Plate
- Raised and Lowered Using UTV Winch



SPECIFICATIONS

Model	UTVST54
Cutting Width	54"
Motor Type	Vanguard 14HP
Manual	pull start
Clutch	Manual belt
Rotor	9"
Hood Rotator	Electric
Hood Deflector	Manual
Cutting Edge	Bolt on 0.134" x 1-1/2"
Overall Width	56"
Overall Depth	22"
Main Body Height	16"
Weight	335 lbs.
List Price	Call for pricing

54 INCH CUTTING WIDTH

UNIVERSAL UTV MOUNT

ELECTRIC HOOD ROTATOR

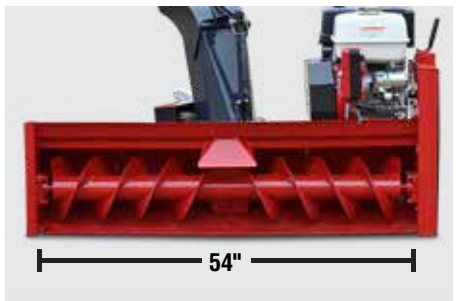

Commercial Sidewalk SnowThrower

SPECIFICATIONS

2000 Commercial Series Sidewalk SnowThrower - 540 RPM

Models	S2048	S2054	S2060
HP	25-55	25-55	25-55
Width	48"	54"	60"
Mount	CAT. 2	CAT. 2	CAT. 2
PTO Drive (RPM)	540	540	540
Stages	1	1	1
Rotor	24"	24"	24"
Oil Bath Chain	Std.	Std.	Std.
Cutting Edge	V-Edge with Trip	V-Edge with Trip	V-Edge with Trip
Skid Shoes	Carbide Shoes & Side Plates	Carbide Shoes & Side Plates	Carbide Shoes & Side Plates
Chute Rotator	Hyd.	Hyd.	Hyd.
Deflector Stages	2	2	2
Chute Deflector (Man/Hyd)	Hyd.	Hyd.	Hyd.
Weight	900 lbs.	1,120 lbs.	1,300 lbs.
List Price	Call for Pricing	Call for Pricing	Call for Pricing

2000 Commercial Series Sidewalk SnowThrower - 1000 RPM

Models	S2048/1000	S2054/1000	S2060/1000
HP	50-75	50-75	50-75
Width	48"	54"	60"
Mount	CAT. 2	CAT. 2	CAT. 2
PTO Drive (RPM)	1,000	1,000	1,000
Stages	1	1	1
Rotor	24"	24"	24"
Oil Bath Chain	Std.	Std.	Std.
Cutting Edge	V-Edge with Trip	V-Edge with Trip	V-Edge with Trip
Skid Shoes	Carbide Shoes & Side Plates	Carbide Shoes & Side Plates	Carbide Shoes & Side Plates
Chute Rotator	Hyd.	Hyd.	Hyd.
Deflector Stages	2	2	2
Chute Deflector (Man/Hyd)	Hyd.	Hyd.	Hyd.
Weight	900 lbs.	1,120 lbs.	1,300 lbs.
List Price	Call for Pricing	Call for Pricing	Call for Pricing

24" ROTOR



2-STAGE DEFLECTOR



HYDRAULIC CHUTE ROTATOR



**NEW
PRODUCT**



FEATURES

- Carbide Skid Shoes & Side Plates
- Oil Bath Chain
- Spring Loaded Carbide Side Plates
- Frame Linkage
- V-Trip Cutting Edge

OPTIONS

- Hydraulic Bank Cutters

**NEW
PRODUCT**



FEATURES

- Hydraulic Chute Rotator
- Hydraulic 2-Stage Deflector
- 6-Blade Fan
- Dual Augers with Ribbon Flighting
- Adjustable Skid Shoes
- Skid Shoes & Side Plates Made with AR400 Steel
- 1/2" x 6" Heat Treated Bolt-On Cutting Edge
- Oil Bath Chain

OPTIONS

- Fixed Bank Cutters
- Hydraulic Steering Bank Cutters
- Truck Loading Chute
- Work Light Kit

SPECIFICATIONS

Models	4097	4108	4120
HP (Rec.)	200	200	200
Cutting Width	97"	108"	120"
Main Body Height	47"	47"	47"
Mount	CAT. 2 & 3	CAT. 2 & 3	CAT. 2 & 3
Impeller (Fan)	36" - 3/8" AR400		
Impeller Depth	12"	12"	12"
Impeller Blades	6	6	6
Impeller Output Shaft	2-1/2"	2-1/2"	2-1/2"
Rotating Housing	N/A	N/A	N/A
PTO Drive (RPM)	1,000	1,000	1,000
Stages	2	2	2
Rotor	Ribbon Flighting (Flight Notching Available)		
Rotor (Tube)	4-1/2" OD Heavy Wall		
Rotor (Flighting)	1/2" x 3" (Bottom) 5/16" x 2-1/4" (Top)		
Rotor (Diameter)	23" (Bottom) 15" (Top)		
Rotor (Drive Shaft)	1-3/4"	1-3/4"	1-3/4"
Roller Chain	#100	#100	#100
Cutting Edge	1/2" x 6" Heat Treated Bolt-On		
End Plates	3/8" AR400 x 48" High		
Chute Diameter	13"	13"	13"
Chute Rotator	Hydraulic	Hydraulic	Hydraulic
Deflector Stages	2	2	2
Chute Deflector	Hydraulic	Hydraulic	Hydraulic
Work Light Kit	Standard (TL Models Only*)		
Weight (LBS.)	3,230	3,350	3,485
List Price	Call for Pricing	Call for Pricing	Call for Pricing

RH Models*	4097RH	4108RH	4120RH
Rotating Housing	Standard	Standard	Standard
Weight (LBS.)	3,490	3,610	3,745
List Price	Call for Pricing	Call for Pricing	Call for Pricing

* RH models have the same specs as the corresponding models above, however they include a rotating fan housing.



ROTATING FAN HOUSING FOR SIDE DISCHARGE

* Only on RH models

Steiner/Ventrac Snowblowers

**NEW
PRODUCT**



FEATURES

- Designed to fit Steiner and Ventrac tractor
- Hydraulic chute rotation for smooth blowing
- Ideal for rural driveways and smaller commercial yards

SPECIFICATIONS

Models	SBVEN48	SBVEN54
Cutting width	48"	54"
Cutting Edge	3/8 x 1"	
Auger Diam.	14"	
Fan Diam.	21"	
Chute Diam.	8"	
Chute Rotation	Hyd.	
Chute Deflector	Manual	
Body Height	25"	
Drive	Belt drive	
Mount	Steiner/Ventrac	
Weight (LBS.)	475	488
List Price	Call for Pricing	Call for Pricing

BELT DRIVE



HYDRAULIC CHUTE ROTATE



STEINER/VENTRAC MOUNT





HYDRAULIC DEFLECTOR

Hydraulic chute deflector includes the cylinder and the hoses.



Part #	Applicable Models	List Price
SB68HD	Fits 54-72	Call for Pricing
SB78HD	Fits 78-120	Call for Pricing

MULTI-HINGED DEFLECTOR

Meteor's Multi-Hinged Deflector provides you with finer control over where your snow is blown. Cylinder not included.



Part #	Applicable Models	List Price
SB78MHD	Fits 78	Call for Pricing
SB87MHD	Fits 87-87D-97	Call for Pricing
SB108MHD	Fits 97D-120D	Call for Pricing

CHUTE ROTATOR

Meteor Snow Blower chute rotators come in manual (crank), hydraulic (orbital motor), and electric.



Manual

Part #	Description
SB48MR	Fits 48" model
SB60MR	Fits 54" and 60" models
SB68MR	Fits 68" and 72" models
SB78MR	Fits 78" models
SB87MR	Fits 87s, 97s, 87D models
SB60PTMR	Fits 60" Pull Type
SB68PTMR	Fits 68" and 72" Pull Type
SB78PTMR	Fits 78" Pull Type
SB87PTMR	Fits 87" Pull Type
SB97PTMR	Fits 97" Pull Type
List Price	Call for Pricing



Hydraulic

Part #	List Price
SBHR13	Call for Pricing



Electric

Part #	List Price
SBER13	Call for Pricing

TRUCK LOADING CHUTE

- Provides up to 40" of additional Height
- Hydraulic Rotation
- Hydraulic Multi-Hinged Deflector



Part #	Applicable Models	List Price
SB87TLC	87S, 97S, & 87D	Call for Pricing
SB108TLC	97D & 108D	Call for Pricing
SB120TLC	120D	Call for Pricing



3PH Rotary Cutters



FEATURES

- Maximum brush diameter 1"
- 7 year limited warranty
- Cat. 1 3PH
- Adjustable cutting height 2" – 10"
- Floating top link maintains cutting height
- Solid segmented wheels for no flat running
- 2 blade design
- Standard front and rear rubber guards
- Deck protection ring
- Fixed skid shoe

OPTIONS

- Light duty slip clutch for driveline protection
- Chain curtains

SPECIFICATIONS

Model	PRC48LD	PRC48	PRC60	PRC66	PRC72	PRC72HD
Shipping Weight (LBS.)	320	380	500	560	625	635
3PH Mount	Cat. 1	Cat. 1	Cat. 1	Cat. 1	Cat. 1	Cat. 1
Cutting Height	2" - 10"	2" - 10"	2" - 10"	2" - 10"	2" - 10"	2" - 10"
Cutting Path	48"	48"	60"	66"	72"	72"
Max Brush Diameter	1"	1"	1"	1"	1"	1"
Tip Speed (Ft/Min)	13100	13100	12462	13708	14955	14955
Wheels	16" (Air Filled)		16" (Segmented)			
Blades	½" x 3"	½" x 3"	½" x 3"	½" x 3"	½" x 3"	½" x 3"
Tractor HP (min)	20	20	30	40	50	50
PTO RPM	540	540	540	540	540	540
Gearbox Rating	40	40	60*	60*	60*	75*
Deck	12 ga	12 ga	12 ga	12 ga	12 ga	12 ga
Stump Jumper	Yes	Yes	Yes	Yes	Yes	Yes
Rubber Guard	Std.	Std.	Std.	Std.	Std.	Std.
Protection (Std./Opt.)	Shear Pin / Slip Clutch	Shear Pin / Slip Clutch	Shear Pin / Slip Clutch	Shear Pin / Slip Clutch	Shear Pin / Slip Clutch	Slip Clutch (Std.)

List Price (Shear Pin)	PRC48LD Call for Pricing	PRC48 Call for Pricing	PRC60 Call for Pricing	PRC66 Call for Pricing	PRC72 Call for Pricing	
List Price (Slip Clutch)	PRC48LDS Call for Pricing	PRC48S Call for Pricing	PRC60S Call for Pricing	PRC66S Call for Pricing	PRC72S Call for Pricing	Call for Pricing

*Based on field performance



Chain Guards *For all 3PH Models. Includes both front and back chains.*

Part # (Chain)	List Price
PRC48CHAIN	Call for Pricing
PRC60CHAIN	Call for Pricing
PRC66CHAIN	Call for Pricing
PRC72CHAIN	Call for Pricing



Slip Clutch

Part #	Description	List Price
PRCSC	Optional Light Duty Slip Clutch	Call for Pricing

3PH Rotary Cutters - 700 Series



FEATURES

- 7" Deck Height
- Maximum brush diameter 2"
- 7 year limited warranty
- Cat. 1 3PH
- Adjustable cutting height 1.5" – 13"
- Floating top link
- Solid segmented wheels
- 2 blade design with stump jumper
- Standard front and rear rubber guards
- Deck protection ring
- Stump jumper
- Fixed skid shoe

OPTIONS

- Light duty slip clutch for driveline protection
- Chain curtains

SPECIFICATIONS

Model	MKRC748	MKRC760	MKRC766	MKRC772	MKRC772HD	MKRC784HD
Cut Width	48"	60"	66"	72"	72"	84"
Weight (LBS.)	420	535	605	640	730	840
Hitch	Cat. 1 Quick Hitch Compatible					
Cutting Height	1.5" - 13" / 10 Positions					
Max Brush Diameter	2"					
Tip Speed (Ft/Min)	13100	12462	13708	14955	15260	17803
Wheels	16" Segmented					X2
Blades	1/2" x 3"					
Tractor HP (min)	22	30	40	50	50	60
PTO RPM	540 RPM	540 RPM	540 RPM	540 RPM		
Gearbox Rating *	40	60	60	60	75	75
Deck	10 ga	10 ga	10 ga	10 ga	10 ga	10 ga
Deck Height	7"	7"	7"	7"	7"	7"
Skirt Thickness	3/16"	3/16"	3/16"	3/16"	3/16"	3/16"
Stump Jumper	Yes (Round)	Yes (Round)	Yes (Round)	Yes (Round)		
Rubber Guard	Std.	Std.	Std.	Std.	Std.	Std.
Protection	Shear Pin	Shear Pin	Shear Pin	Shear Pin	Slip Clutch	Slip Clutch
List Price (Shear Pin)	MKRC748 Call for Pricing	MKRC760 Call for Pricing	MKRC766 Call for Pricing	MKRC772 Call for Pricing	Call for Pricing	Call for Pricing
List Price (Slip Clutch)	MKRC748S Call for Pricing	MKRC760S Call for Pricing	MKRC766S Call for Pricing	MKRC772S Call for Pricing	Call for Pricing	Call for Pricing

* Based on field performance



Chain Guards *For all 3PH Models. Includes both front and back chains.*

Part # (Chain)	List Price
PRC48CHAIN	Call for Pricing
PRC60CHAIN	Call for Pricing
PRC66CHAIN	Call for Pricing
PRC72CHAIN	Call for Pricing

Slip Clutch

Part #	Description	List Price
PRCSC	Optional Light Duty Slip Clutch	Call for Pricing

3PH Rotary Cutters Plus



FEATURES

- Maximum brush diameter 2"
- 7 year limited warranty
- Cat. 1 & Cat. 2 3PH
- Draw bar hitch (PRCPLUS120)
- Adjustable cutting height 2" – 10"
- Floating top link maintains cutting height
- Solid segmented wheels (PRCPLUS60 – PRCPLUS96)
- Pneumatic wheels (PRCPLUS120)
- 3 blade design with stump jumper
- Standard front and rear rubber guards
- Deck protection ring
- Slip clutch to protect the drive line
- Bolt on skid shoe

OPTIONS

- Chain curtains

Blade Assembly



Floating Top Link



Segmented Wheel



Slip Clutch



SPECIFICATIONS

Model	PRCPLUS60	PRCPLUS72	PRCPLUS84	PRCPLUS96	PRCPLUS120	PRCPLUS120-3PH
Shipping Weight (LBS.)	595	775	1045	1530	2320	2045
Hitch Type	Cat. 1 & 2 Quick Tach compatible				Draw Bar Hitch	Cat. 2
Cutting Height	2" - 10"	2" - 10"	2" - 10"	2" - 10"	2" - 10"	2" - 10"
Cutting Path	60"	72"	84"	96"	120"	120"
Max Brush Diameter	2"	2"	2"	2"	2"	2"
Tip Speed (Ft/Min)	12,462	15,260	17,803	16,500	14,500	14,500
Wheel Type (Qty.)	16" Segmented (1)	16" Segmented (1)	16" Segmented (2)	16" Segmented (2)	16" Pneumatic (2)	16" Pneumatic (2)
Blades	3 - 1/2" x 3"	3 - 1/2" x 3"	3 - 1/2" x 3"	3 - 1/2" x 3"	6 - 1/2" x 4"	6 - 1/2" x 4"
Tractor HP (min)	30-40	60	60	80	80	80
PTO RPM	540	540	540	540	540	540
Gearbox Rating *	75 HP	75 HP	90 HP	100 HP	120 HP	120 HP
Deck	3/16"	3/16"	3/16"	3/16"	9GA	9GA
Stump Jumper	Yes	Yes	Yes	Yes	Yes	Yes
Protection	Slip Clutch	Slip Clutch	Slip Clutch	Slip Clutch	Slip Clutch	Slip Clutch
List Price	Call for Pricing	Call for Pricing	Call for Pricing	Call for Pricing	Call for Pricing	Call for Pricing

* Based on field performance



CHAIN GUARDS *For all 3PH Models. Includes both front and back chains.*

Part # (Chain)	List Price
PRC60CHAIN	Call for Pricing
PRC72CHAIN	Call for Pricing
PRC84CHAIN	Call for Pricing
PRC96CHAIN	Call for Pricing
PRC120CHAIN	Call for Pricing



DRAW BAR KIT

For 84" & 96" models. Kit consists of components shown in black in this image; red components for illustration only.

Part #	List Price
PRCDB84-96	Call for Pricing

Rotary Cutters - Wing



FEATURES

- 15' dual wing rotary cutter
- 4 heavy duty gearboxes, each covered with 7 year limited warranty
- Transport lock for each wing
- 1.5" diameter cutting capacity
- Each wing can float to conform to ground contours

SPECIFICATIONS

Model	PW180
Shipping Weight (LBS.)	4,400
3PH Mount	Draw Bar Hitch
Cutting Height	3"-15"
Cutting Path	180"
Max Brush Diameter	1.5"
Overall Width (Wings Down)	184"
Folded Width (Wings Up)	78"
Tip Speed (Ft/Min)	15,100 ft/min on Wings 14,850 ft/min on center
Wheels (Pneumatic)	21"
Blades	9 blades 1/2"x4"
Tractor HP (min)	75HP
PTO RPM	540
Gearbox Rating (Wing)	140 HP
Gearbox Rating (Center)	105 HP
Gearbox Rating (Divider)	87 HP
Deck	3/16"
Stump Jumper	Yes
Protection	Independent Slip Clutch on Each Spindle
Wing Float Range(degrees)	2 down and 33 up
List Price	Call for Pricing
Tandem Option (price for 1 pair)	Call for Pricing
Solid Wheel Option Set of 6 wheels in lieu of standard	Call for Pricing



FEATURES

- Maximum brush diameter 2"
- 3 blade cutting assembly
- Integrated push bar
- Relief valve for protection
- Chain curtain
- Floating linkage allows the cutter to follow ground contour

SPECIFICATIONS

Model	Description	Brush Diameter	Deck Thickness	Weight (LBS.)	List Price
PRCH60-A	60" Rotary Cutter	2"	3/16"	760	Call for Pricing
PRCH60-B	60" Rotary Cutter	2"	3/16"	760	Call for Pricing
PRCH60-B+	60" Rotary Cutter	2"	3/16"	760	Call for Pricing
PRCH72-A	72" Rotary Cutter	2"	3/16"	860	Call for Pricing
PRCH72-B	72" Rotary Cutter	2"	3/16"	860	Call for Pricing
PRCH72-B+	72" Rotary Cutter	2"	3/16"	860	Call for Pricing
PRCH72-C	72" Rotary Cutter	2"	3/16"	860	Call for Pricing
PRCH72-C+	72" Rotary Cutter	2"	3/16"	860	Call for Pricing
PRCH72-D	72" Rotary Cutter	2"	3/16"	860	Call for Pricing



Flow Rates	Pack. Codes
14-17 GPM	A
18-20 GPM	B
20-22 GPM	B+
23-26 GPM	C
27-33 GPM	C+
33-40 GPM	D

To ensure optimum performance, hydraulic output must match motor package.

OPTIONAL BOLT-ON GAUGE WHEEL

- 16" segmented wheel
- 2" - 9" wheel adjustment / 5 holes



Extreme Duty Brush Cutters

**NEW
PRODUCT**



HEAVY DUTY 10" CUT CAPACITY

Easily power through dense brush, woody vegetation even 10 inch diameter trees across fields, forests and trails.



OVERSIZED 1" THICK ROTOR

78" diameter oversized rotor is manufactured using a 1" thick steel plate.



4 REPLACEABLE FLAIL KNIVES

Mounted on the rotor are 4 replaceable pivoting flail knives designed to deliver maximum centrifugal velocity and shear force on every rotation.



DIRECT MOUNTED MOTOR

The hydraulic radial piston direct mounted motor and heavy duty bearing assembly deliver tip speeds of up to 20,000 ft. per minute and produce powerful torque at lower speeds for continuous cutting and faster recovery.

EXTREME DUTY

BRUSH CUTTER



FEATURES

- 78" Brush Cutter - Skid Steer attachment
 - 86.5" Machine Width
- 10" cut capacity
- Radial Piston Motor (4 pkgs up to 40GPM)
 - Recommend 20+GPM
 - Higher Torque capability at low speeds
 - Up to 4000psi operating pressure
- Heavy duty 1" cutting bar; 4 cutting blades
 - Optional bolt-on inserts
- Tip speed of 20,000 ft/min
- 1/4" deck thickness
- Replaceable skid shoes
- 2200 LBS approximate weight
- Reversible push bar (trees/brush/grass)
- **7 year limited consumer warranty**
1 year limited commercial warranty



REVERSIBLE FRONT PUSH BAR

One side (A) has aggressive teeth for accurate pushing and directional control of larger trees. The reverse side (B) is smooth, intended for flattening dense underbrush.



OPTIONAL BOLT-ON MULCHING KNIVES

Bolt-on mulching knives go on the bottom of the rotor to effortlessly mulch tough stumps and logs.



OPTIONAL CARBIDE CHIPPER KNIVES

Another option for mulching stumps and logs are the optional carbide tipped mulching knives.

SPECIFICATIONS

Model	BCH78XD
Description	78" Brush Cutter
Machine Width	86.5"
Cut Capacity	180"
Max Brush Diameter	10"
Radial Piston Motor	4 pkgs up to 40GPM
Recommended GPM	20+GPM
Torque	Higher Torque capability at low speeds
Operating Pressure	Up to 4000 psi
Blades	4 blades
Heavy Duty Cutting Bar	1"
Tip Speed	20,000 ft/min
Deck Thickness	1/4"
Shipping Weight (LBS.)	2,200
List Price	Call for Pricing

Finishing Mowers



Pictured: Rear Discharge Model

FEATURES

- 7 year limited warranty
- Cat. 1 hitch
- 4 solid rubber tires
- Floating end link
- Taper lock pulleys

SPECIFICATIONS

Model	PFM48RD	PFM60RD	PFM72RD	PFM90RD
Cutting Width	48"	60"	72"	90"
Overall Width	50"	62"	74"	93"
Weight (LBS.)	370	435	525	714
Acres/Hr@5 MPH	2.43	3.03	3.63	4.57
HP Required	14/20	20/25	25/30	30/40
3PH Mount	Cat. 1	Cat. 1	Cat. 1	Cat. 1
RPM @ PTO Shaft	540	540	540	540
Number of Blades	3	3	3	5
Tip Speed (Ft/Min)	15,660	18,000	16,850	16,288
Wheels	Solid Rubber Wheel	Solid Rubber Wheel	Solid Rubber Wheel	Solid
Deck Thickness	10 GA	10 GA	3/16"	3/16"
Cutting Height	2" - 5"	2" - 5"	2" - 5"	2" - 5"
List Price	Call for Pricing	Call for Pricing	Call for Pricing	Call for Pricing



FEATURES

- Retractable Counterweight Shelf
- Hydraulic Tool Rotation
- Hydraulic Tool Lift
- Transport Lock



Rotary Cutter not included.

Stabilizer Arm to Cutter

Various attachment brackets are supplied with the Axis Toolbar to attach the Stabilizer Bar to the cutter. All four adaptors are included.

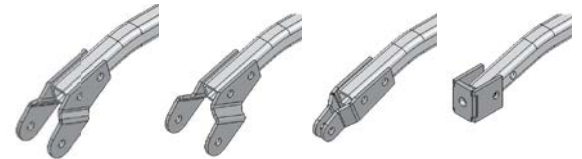

Shown in order: Rotary Cutter, Kodiak, Fork Rear Wheel Style with 180° Wheel Adjuster, Fork Rear Wheel Style with Flat Wheel Adjuster

SPECIFICATIONS

Model	AXIS4	AXIS5-6
Weight (LBS.)	751	900
Offset	60"	84"
3PH Mount	Cat. 1	Cat. 1 & 2
Minimum Tractor Weight (LBS.)	2,900	5,800
Maximum Tool Weight (LBS.)	480	800
4' Rotary Cutter (Not Included)		req. min. 30 HP
5' Rotary Cutter (Not Included)		req. min. 60 HP
6' Rotary Cutter (Not Included)		req. min. 80 HP
Cutting Angle Cyl. Ext.		55°
Cutting Angle Cyl. Ret.		90°
Tractor Remotes Req.		2
Protection	Shear Bolt	Shear Bolt
List Price	Call for Pricing	Call for Pricing

Trail/UTV Mowers



FEATURES

- 44" - 48" Cutting Width
- Briggs & Stratton Engines
- 12 Volt electric start (UTVM48 only)
- Remote e-Stop (UTVM48 only)
- 2 Rotors with 3 blades each
- Adjustable cutting height (2"-7") with ratchet style adjustment
- 3 position hitch for straight or offset cutting
- Flat free tires
- Swivel wheels on front, fixed wheels on rear (UTVM48 Only)



SPECIFICATIONS

Model	UTVM48	UTVM48E
Engine Brand	Briggs & Stratton	Briggs & Stratton
Engine	19 HP	2 Engines (190 CC each)
Starting System	Key (electric)	Pull start
Fuel Tank	3 Gal.	1 Gal.
Battery	12 Volt	N/A
Deck	Rear Discharge	Rear Discharge
Deck Thickness	10 ga	10 ga
Blade Assembly	2 Rotors with 3 Blades each	2 Rotors with 3 Blades each
Cut Width	44"	48"
Cut Height	2" - 7"	2" - 6"
Max Brush Diameter	3/4"	1/2"
Wheels	12" x 3.5" Flat free tires	2 1/2" X 12"
Weight	720 lbs	325 lbs
List Price	Call for Pricing	Call for Pricing



REMOTE E-STOP

Cabled e-Stop can be placed on tow vehicle for easy reach. (UTVM48 Only)



FEATURES

- Electrically Controlled Poly Broom with Remote
- Leaf Bucket with Pivot for Easy Emptying
- Replaceable Durable Mesh Netting
- Flat Free Tires
- 6.5 HP Vanguard Engine



SPECIFICATIONS

Model	MKLS1846
Sweeping Width	46"
Overall Width	65"
Length	95"
Motor (HP)	6.5 HP Vanguard Engine
Brush Diameter	18"
Drive System	Chain - Fully Engaged so the brush turns all the time
Broom Lift	12V Electric
Hopper Capacity	21 Cu.Ft.
Wheels	12" x 3.5" flat free tires
Weight (LBS.)	515
List Price	Call for Pricing



HEIGHT ADJUSTMENT

Height Adjustment is controlled with a switch box with a magnetic base for easy mounting to your tow unit.

Grader Blades



FEATURES

- Five Stops of angle adjustment (Each Forward and Back)
- Full Turn Around
- ½" x 6" Reversible Cutting Edge
- 3/8" Mouldboard (98 Series)
- Quick hitch compatible

SPECIFICATIONS

Model	Max. HP	Width	Mouldboard	Mouldboard Height	Center Pin	3PH Mount	Weight (LBS.)	List Price
MKGB588	45	5'	3/16"	15"	2"	Cat. 1	180	Call for Pricing
MKGB688	45	6'	¼"	15"	2"	Cat. 1	200	Call for Pricing
MKGB788	45	7'	¼"	15"	2"	Cat. 1	215	Call for Pricing
MKGB798	75	7'	3/8"	15"	3"	Cat. 2	577	Call for Pricing
MKGB898	75	8'	3/8"	15"	3"	Cat. 2	616	Call for Pricing

OPTIONS

Model	Description	List Price
MKGB88ANG	Hydraulic Angle - Includes the Hydraulic Cylinder and Hoses	Call for Pricing
MKGB98ANG	Hydraulic Angle - Includes the Hydraulic Cylinder and Hoses	Call for Pricing

Light Duty Grader Blade



FEATURES

- Five Stops of angle adjustment (Forward and back)
- Manual angle adjustment
- 3/16" Mouldboard
- 3/8" x 6" reversible cutting edge
- Quick hitch compatible

SPECIFICATIONS

MKGB567 shown

Model	MKGB467	MKGB567	MKGB667
Horsepower	30 HP	30 HP	30 HP
Hitch		Cat. 1	
Width (in.)	48"	60"	72"
Weight (lbs.)	140	149	155
Reverse		Yes	
Mouldboard		3/16" Material	
Mouldboard Height	15"	15"	15"
Cutting Edge		3/8" x 6" Reversible	
Angle (Control)		Yes (Manual)	
Angle (Position)		5 Stops Forward / 5 Stops Reversed	
List Price	Call for Pricing	Call for Pricing	Call for Pricing

FEATURES

- Angle Manual Adjustment
- Offset Manual Adjustment
- Tilt Manual Adjustment
- 180° Reversible
- Bolt-On Cutting Edge
- Park Stand

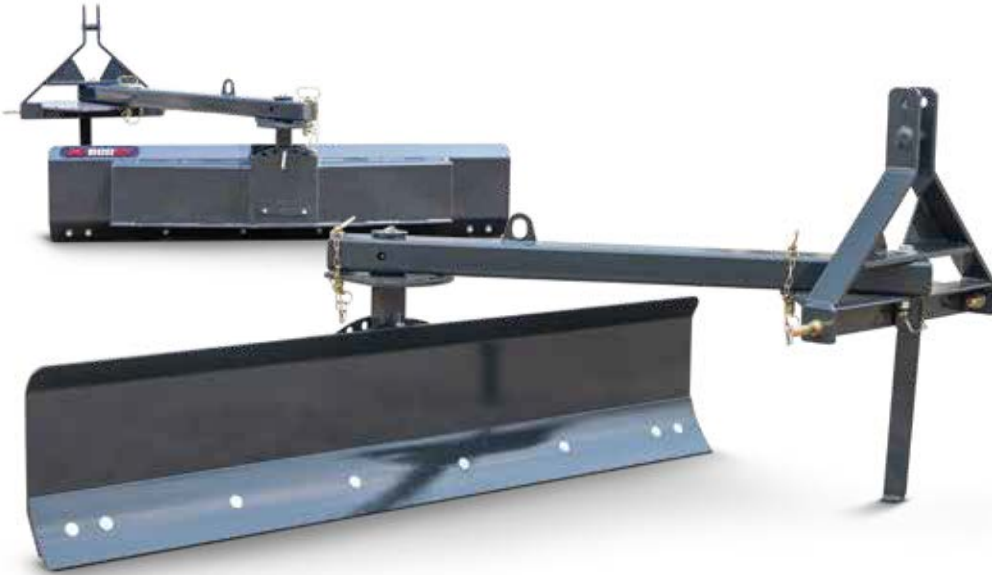

SPECIFICATIONS

Model	MKGB588	MKGB688	MKGB788
HP	30 - 50	30 - 50	30 - 50
Hitch	Cat. 1	Cat. 1	Cat. 1
Width	60"	72"	84"
Weight (LBS.)	250	258	270
Reverse	Yes	Yes	Yes
Mouldboard	¼"	¼"	¼"
Mouldboard Height	15"	15"	15"
Cutting Edge	3/8 x 6 Reversible		
Angle (Control)	Manual	Manual	Manual
Angle (Position)	5 Forward / 5 Reversed		
Offset Adjust	5 Positions	5 Positions	5 Positions
Tilt Adjust	5 Positions	5 Positions	5 Positions
List Price	Call for Pricing	Call for Pricing	Call for Pricing

RUBBER CUTTING EDGE

These optional rubber cutting edges are ideal for snow removal, reducing damage to driveways.



(Optional on Light Duty, Standard, & Offset Tilt Grader Blades)

Model	Description	List Price
MKGBRCE5	5' Rubber Cutting Edge Kit	Call for Pricing
MKGBRCE5.5	5.5' Rubber Cutting Edge Kit	Call for Pricing
MKGBRCE6	6' Rubber Cutting Edge Kit	Call for Pricing
MKGBRCE7	7' Rubber Cutting Edge Kit	Call for Pricing
MKGBRCE8	8' Rubber Cutting Edge Kit	Call for Pricing
MKGBRCE9	9' Rubber Cutting Edge Kit	Call for Pricing
MKGBRCE10	10' Rubber Cutting Edge Kit	Call for Pricing

HYDRAULIC KIT

Includes hoses, cylinders, bolt-on plates, hardware.



Model	Description	List Price
MKGBOTAng	Angle Kit	Call for Pricing
MKGBOTTilt	Tilt Kit	Call for Pricing

XD Grader Blades



FEATURES

- Extreme Duty Grader Blade
- Available up to 14' grading path
- For tractors up to 250 HP
- Hydraulic cylinders control the blade angle, blade tilt and offset of the arm



FEATURES



**HYDRAULIC
ANGLE**

**HYDRAULIC
TILT**

**HYDRAULIC
OFFSET**

SPECIFICATIONS

Model	8XD-100	9XD-100	9XD-150	10XD-150	12XD-250	14XD-250
Horse Power (Max.)	100	100	150	150	250	250
3PH Mount	Cat. 2 & 3					
Mouldboard Thickness	5/16"				3/8"	3/8"
Mouldboard Width	96"	108"	108"	120"	144"	168"
Mouldboard Height	20"				20"	20"
Offset Adjustment	27" left or right (hydraulic)					
Adjustment Angle	32° left or right (hydraulic)			37° left or right (hydraulic)		
Adjustment Tilt	13° blade adjustment (hydraulic)					
King Pin	3-1/2"	3-1/2"	4"	4"	5"	5"
Cutting Edge	High Carbon 1/2" x 6" (reversible)					
Weight (LBS.)	1,572	1,666	1,695	1,745	1,925	2,075
List Price	Call for Pricing	Call for Pricing	Call for Pricing	Call for Pricing	Call for Pricing	Call for Pricing

OPTIONS

Part #	Description	Weight	List Price
MKGBXD-TW	Tail Wheel Kit	310 lbs.	Call for Pricing

TAIL WHEEL KIT





FEATURES

- Reversible Hardened Steel Cutting Edges
- 2 Cutting Edges allow you push or pull material
- Height Adjustable Ripper Shanks
- Bolt On 3PH Design
- Quick hitch compatible



SPECIFICATIONS

Model	Width	Shanks	Mouldboard	End Plates	3PH Mount	Max HP	Weight (LBS.)	List Price
448 STD	4'	4	3/16"	1/4"	Cat. 1	35 HP	308	Call for Pricing
560 STD	5'	4	3/16"	1/4"	Cat. 1	35 HP	348	Call for Pricing
566 HD	5'6"	4	3/16"	1/4"	Cat. 1	45 HP	415	Call for Pricing
672 HD	6'	5	3/16"	1/4"	Cat. 1	45 HP	450	Call for Pricing
784 HD	7'	6	3/16"	1/4"	Cat. 1	45 HP	500	Call for Pricing
784 DLX	7'	6	1/4"	1/4"	Cat. 2	75 HP	555	Call for Pricing
896 DLX	8'	7	1/4"	1/4"	Cat. 2	75 HP	612	Call for Pricing

HEIGHT ADJUSTABLE

The height adjustable scarifier shanks break up the soil allowing the cutting edge to redistribute the material as the box scraper is pulled along.



REPLACEABLE SCARIFIER TIPS

Control how deep the scarifier rips with the Box Scrapers easy to use pin adjustment on the shanks. Removeable shanks feature replaceable scarifier tips.

Replaceable Scarifier Tips on removeable shanks.

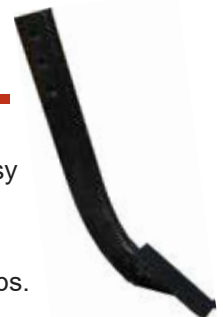

Land Levelers



LAND LEVELER

These rugged scrapers come in a range of sizes from 8 to 12 feet to fit your needs and your equipment. Standard on all models is our 1/2 inch thick reversible hardened cutting edge, ready to smooth out the bumps and fill in the hollows. Cutting depth is controlled by a 3"x12" hydraulic cylinder so you can decide how much of a bite to take and adjust on the go. All models are well suited for feedlot and soil reclamation or swale cutting.



FEATURES

- 1/2" x 6" reversible hardened cutting edge
- Equipped with a 15" jack
- 3" x 12" hydraulic lift cylinder
- 3" x 6" cylinder to tilt 10° each way

TRAILED MODEL SPECIFICATIONS

Trailed Models	LLT-8	LLT-10	LLT-12
Width	8'	10'	12'
Mount	Hitch	Hitch	Hitch
Horse Power (Max.)	165	165	165
Tilt	Yes	Yes	Yes
Cutting Edge	Single	Single	Single
Side Plate	3/8"	3/8"	3/8"
Mouldboard	1/4"	1/4"	1/4"
Wear Plate	NA	NA	NA
Skidbar	1/2" Reversible	1/2" Reversible	1/2" Reversible
Weight	1,555	1,771	1,898
List Price	Call for Pricing	Call for Pricing	Call for Pricing



3PH MODEL SPECIFICATIONS

3PH Model	LLP-8	LLP-10	LLP-12	LLP2-8	LLP2-10	LLP2-12
Width	8'	10'	12'	8'	10'	12'
Mount	3PH	3PH	3PH	3PH	3PH	3PH
Horse Power (Max.)	165	165	165	165	165	165
Tilt	NA	NA	NA	NA	NA	NA
Cutting Edge	Single			Double		
Side Plate	3/8"	3/8"	3/8"	3/8"	3/8"	3/8"
Mouldboard	1/4"	1/4"	1/4"	1/4"	1/4"	1/4"
Wear Plate	3/4"	3/4"	3/4"	3/4"	3/4"	3/4"
Skidbar	NA	NA	NA	NA	NA	NA
Weight	838	956	1,077	945	1,090	1,238
List Price	Call for Pricing	Call for Pricing	Call for Pricing	Call for Pricing	Call for Pricing	Call for Pricing



ADJUSTABLE SKID BARS



TILT INDICATOR



TRANSPORT LOCK



Grader Levelers

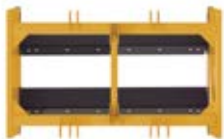

Top View



FEATURES

- Two ½" x 6" Reversible Cutting Edges
- 3/8" x 2 Reversible Skid Shoes
- Cutting edges can be manually adjusted to your desired cutting depth for optimal performance
- Order Mount separately (3PH or Skidsteer Adaptor)

OPTIONS

- Mount – Select the correct mount for application at time of order

SPECIFICATIONS

Model	Working Width	Overall Width	Skid Shoes	Mouldboard Thickness	Cutting Edge	Weight (LBS.)	List Price
GL578	60"	65"	3/8" x 2 Reversible	¼"	1" Adjustment	600	Call for Pricing
GL678	72"	77"	3/8" x 2 Reversible	¼"	1" Adjustment	665	Call for Pricing
GL778	84"	89"	3/8" x 2 Reversible	¼"	1" Adjustment	730	Call for Pricing
GL878	96"	101"	3/8" x 2 Reversible	¼"	1" Adjustment	796	Call for Pricing

NOTE: Hitch must be ordered separately.

OPTIONS

Options	Part #	Weight (LBS.)	List Price
Optional Skidsteer Adaptor	MKGLSSMNT	156	Call for Pricing
Optional 3PH Adaptor (Cat. 1 & 2)	MKGL3PTMNT	36	Call for Pricing



Top View



FEATURES

- Two angled ½" x 6" Reversible Cutting Edges
- Cutting Edge Angled between 5° - 9° depending on model
- 3/8" x 2 Reversible Skid Shoes
- Cutting edges can be manually adjusted to your desired cutting depth for optimal performance
- Order Mount separately (3PH or Skidsteer Adaptor)

OPTIONS

- Mount – Select the correct mount for application at time of order

SPECIFICATIONS

Model	Working Width	Overall Width	Skid Shoes	Mouldboard Thickness	Cutting Edge	Cutting Angle (Deg.)	Weight (LBS.)	List Price
GL578A	60"	65"	3/8" x 2 Reversible	¼"	1" to -0.5"	9	568	Call for Pricing
GL678A	72"	77"	3/8" x 2 Reversible	¼"	1" to -0.5"	7	632	Call for Pricing
GL778A	84"	89"	3/8" x 2 Reversible	¼"	1" to -0.5"	6	697	Call for Pricing
GL878A	96"	101"	3/8" x 2 Reversible	¼"	1" to -0.5"	5	761	Call for Pricing

NOTE: Hitch must be ordered separately.

OPTIONS

Options	Part #	Weight (LBS.)	List Price
Optional Skidsteer Adaptor	MKGLSSMNT	156	Call for Pricing
Optional 3PH Adaptor (Cat. 1 & 2)	MKGL3PTMNT	36	Call for Pricing

Land Planes

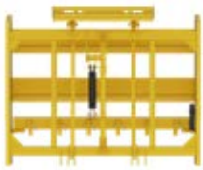

Top View



FEATURES

- Two ½" x 6" Reversible Cutting Edges
- 3/8" x 2 Reversible Skid Shoes
- Cutting Edges are adjustable in 1" increments for optimal performance
- Hydraulically adjustable scarifier bar
- Grader quality shanks with replaceable tips
- Order Mount separately (3PH or Skidsteer Adaptor)

OPTIONS

- Mount – Select the correct mount for application at time of order

SPECIFICATIONS

Model	LP678	LP778	LP878
Working Width	72"	84"	96"
Overall Width	77"	89"	101"
Length	69.5"	69.5"	69.5"
Shank (Qty.)	6	6	8
Shank Tube		4" x 6" x ¼"	
Cutting Edge (x2)	Hardened ½" - Reversible 1" Adjustments		
Skid Shoes	3/8" x 2 Reversible		
Cylinder	Dual Hydraulic Cylinders for shank rotation		
Weight (LBS.)	1,140	1,240	1,350
List Price	Call for Pricing	Call for Pricing	Call for Pricing

NOTE: Hitch must be ordered separately.

OPTIONS

Options	Part #	Weight (LBS.)	List Price
Optional Skidsteer Adaptor	MKLPSSMNT	156	Call for Pricing
Optional 3PH Adaptor (Cat. 1 & 2)	MKLP3PTMNT	36	Call for Pricing

FEATURES

- Cat. 1 Quick Tach compatible
- 5/16" x 1" x 15.25" spring tines
- 5 forward and 3 reverse positions with manual adjustment

OPTIONS

Part #	Description	List Price
MKGB88ANG	Hydraulic Angle Kit	Call for Pricing
MKLRGWK	Gauge Wheel Kit	Call for Pricing

SPECIFICATIONS

Model	MKLR4	MKLR5	MKLR6	MKLR7
Width	4'	5'	6'	7'
MAX HP	50	50	50	50
Weight (LBS.)	245	250	263	285
Tines	24	30	36	42
List Price	Call for Pricing	Call for Pricing	Call for Pricing	Call for Pricing

Shown with optional gauge wheel kit.



Cultivators

FEATURES

- Adjustable S-tine configuration
- Ideal for cultivating small fields and gardens

SPECIFICATIONS

Model	CU-5	CU-6	CU-7
Working Width	60"	72"	84"
Overall Width	60-1/2"	72-1/2"	84-1/2"
Weight (LBS.)	164	193	222
Tines (Heat Treated)	9 tines	11 tines	13 tines
3PH Mount	Cat. 1	Cat. 1	Cat. 1
List Price	Call for Pricing	Call for Pricing	Call for Pricing



OPTIONAL GAUGE WHEEL KIT

Part #	List Price
CUWK	Call for Pricing

(4" depth adjustment, 2.5"x12" rubber wheel)



Track Curry



FEATURES

- Two rows of adjustable S-Tines
- Adjustable Leveling Bar
- 12" Rolling Drum (adjustable)
- Spill Plates direct material into the working width
- Quick Hitch Compatible

OPTIONS

- Wing – levels and reclaims material around the edge of arenas
- Scarifier Bar – Used for working up hard pack
- Sprinkler Kit

SPILL PLATES

Every MK Martin Track Curry comes with two standard spill plates. These funnel any excess material into the Track Curry's path, ensuring your arena or track keeps looking its best.



SPECIFICATIONS

Model	TC-5	TC-6	TC-7	TC-8
Working Width	5'	6'	7'	8'
Number of Shanks	13	15	17	19
Shank Size	1-1/4" x 3/8" x 22"			
Shank Clearance	16"	16"	16"	16"
3PH Mount	Cat. 1	Cat. 1	Cat. 1	Cat. 1
HP Rating	18 - 32	22 - 39	26 - 47	30 - 53
Weight (LBS.)	460	530	640	725
Leveling Bar	1/2" x 6" (double beveled)			
List Price	Call for Pricing	Call for Pricing	Call for Pricing	Call for Pricing



WING

The optional Track Curry wing from MK Martin easily levels the edge of the riding arena for a clean and professional look.



SCARIFIER BAR

Dig deeper with the optional scarifier bar. Each bar is individually height adjustable, or can be removed or inverted for the right amount of action.



SPRINKLER KIT

Equipped with a 25 gallon tank, the optional sprinkler kit reduces the amount of dust being thrown into the air when working with dry material.

OPTIONS

Part #	Option	List Price
TC Wing	Track Curry Wing	Call for Pricing
TCSA5	5' Scarifier Bar	Call for Pricing
TCSA6	6' Scarifier Bar	Call for Pricing
TCSE12	12" Scarifier Extension (x2)	Call for Pricing
TCSK	Sprinkler Kit	Call for Pricing

For 7 & 8 foot scarifier bars please order the following parts combinations to match your width.

Width	Combine
7 foot	TCSA5 + TCSE12
8 foot	TCSA6 + TCSE12

3PH Rotary Tillers



FEATURES

- Replaceable Bolt-On Tines
- Self Lubricating Chain Drive
- Adjustable Skidshoes
- Floating Deflector
- Gear Box
- 3PH Mount Offset
- Slip Clutch

SPECIFICATIONS

Models	RT486	RT546	RT606	RT726
Horsepower	15-30 HP	20-40 HP	20-50 HP	25-60 HP
Hitch	Cat. 1	Cat. 1	Cat. 1	Cat. 1
Inner Width (in.)	50	54	58	74
Overall Width (in.)	55.375	59.375	63.375	79.375
Weight (lbs.)	491	514	525	636
Number of Flanges	6	6	7	9
Tines/Flange	6 (C-Shape)	6 (C-Shape)	6 (C-Shape)	6 (C-Shape)
Flange Spacing (in.)	7.75	7.75	7.75	7.75
Max Tillage Depth (in.)	6.5	6.5	6.5	6.5
Number of Skid Shoe Settings	5	5	5	5
Rotor Diameter (in.)	17"	17"	17"	17"
Rotor Speed @ 540 PTO (RPM)	211	211	211	211
Gearbox (HP)	50HP @ 540	50HP @ 540	50HP @ 540	50HP @ 540
Drive Chain	#80	#80	#80	#80
List Price	Call for Pricing	Call for Pricing	Call for Pricing	Call for Pricing



FEATURES

- Skid steer attachment plate
- 74" working width
- 9 tine flanges
- 6 tines per flange
- Working depth 6.5"
- 17" rotor

SPECIFICATIONS

Models	RT726SF	RT726HF
Flow	Standard	High Flow
Hitch	Skidsteer Attachment Plate	Skidsteer Attachment Plate
Inner Width (in.)	74	74
Overall Width (in.)	79.375	79.375
Weight (lbs.)	725	725
Number of Flanges	9	9
Tines/Flange	6 (C-Shape)	6 (C-Shape)
Flange Spacing (in.)	7.75	7.75
Max Tillage Depth (in.)	6.5	6.5
Rotor Diameter (in.)	17"	17"
Drive Chain	#80	#80
List Price	Call for Pricing	Call for Pricing

Flow Rates	
Standard	16-28 GPM
High Flow	28-40 GPM

To ensure optimum performance, hydraulic output must match motor package.

Garden Hillers



FEATURES

- Shanks & sweeps keep soil loose after tractor compaction
- Adjustable disc height and horizontal spacing
- Discs angle is adjustable
- 2x2 steel tube construction

SPECIFICATIONS

Model	GH60
Width	60"
Hitch	Cat. 1
Disc	14"
Weight	100 lbs.
List Price	Call for Pricing

FEATURES

- 3PH hookup Cat. 1
- Quick and easy dump
- Raise and lower to desired height for loading
- Heavy duty tubular sub frame
- 14 GA. material box structure



SPECIFICATIONS

Model	Cap	Size	Weight (LBS.)	List Price
DB495	30 cu ft	18" x 48" x 48"	290	Call for Pricing
DB395	10 cu ft	10" x 36" x 36"	120	Call for Pricing

Weight Boxes

FEATURES

- 3.5 cu. ft. internal volume
- 525 lbs maximum holding weight
- Cat. 1 & 2 3PH compatible
- Tool holder
- Clean out hatch
- 2" Hitch receiver

**NEW
PRODUCT**



SPECIFICATIONS

Model	MKWB
Hitch Type	Cat. 1 & 2
Box Volume	3-½ cu ft
Max Weight (box and fill) (LBS.)	575
Max Weight (fill only) (LBS.)	525
Quick Hitch Compatible	Yes
Shipping Weight (LBS.)	104
List Price	Call for Pricing

Fill Type	Weight Per Cubic Foot (lbs.)
Concrete	150
Gravel	110
Sand	100

Trailer Backhoe

**NEW
PRODUCT**



FEATURES

- 360 degree rotation
- 4ft 11" working depth
- 1764lbs (800kg) digging force
- Towable design

** 7 year warranty does not apply*





SPECIFICATIONS

BT810	Standard Setup
Engine HP	420CC Briggs & Stratton Gasoline
Capacity (HP)	13.5 hp
Start up	Electric
Digging Force	800 kg/1,764 lbs
Bucket Reach	204 cm / 6' 8"
Working Depth	160 cm / 5 ft 3 inches
Total Weight	600 kg / 1323 lbs
Total Reach of Boom	270 cm / 8' 10"
Hydraulic Pressure	16 MPA / 2,320 psi
List Price	Call for Pricing



BRIGGS & STRATTON GASOLINE ENGINE



5 FOOT WORKING DEPTH



360 DEGREE ROTATION



ELECTRIC START



CURVED BOOM DESIGN



12" & 18" BUCKET WITH MECHANICAL THUMB



Gravity Boxes



SPECIFICATIONS

Model	MKGW3200			MKGW5000		
Extension	N/A	8"	19"	N/A	8"	12"
Capacity (Bushels)	320	375	450	500	570	605
Hopper Construction	14 GA.			12 GA.		
Under Structure	3" x 6" x .188 wall rectangular tube			4" x 8" .188" wall rectangular tubing		
Unloading Door	45" width			57" width (standard) 28" width x2 (divider)		
Chute Height	17"-20"			17"-21"		
Box Dimensions						
Length	158"	158"	158"	196"	196"	196"
Width	96"	96"	96"	101"	101"	101"
Height (less wagon)	78"	86"	98"	89"	98"	101"
Height (wagon & 22.5" wheel)	102"	110"	122"	123"	131"	135"
Weight (LBS.)	1,980	2,130	2,270	3,610	3,845	3,915
Wheel Base	112"			142"		
Suggested Wagon	275 Horst Wagon - 425/22.5 Tires			365 Horst Wagon - 425/22.5 Tires		
List Price	Call for Pricing	Call for Pricing	Call for Pricing	Call for Pricing	Call for Pricing	Call for Pricing
List Price c/w Horst Wagon*	Call for Pricing	Call for Pricing	Call for Pricing	Call for Pricing	Call for Pricing	Call for Pricing
Suggested Wagon Included	275 Horst Wagon - 425/22.5 Tires			365 Horst Wagon - 425/22.5 Tires		

* Wagon options not included in list price. Wagon options are available at an additional cost.

WAGON OPTIONS

Part #	Description	List Price
horstWA-BR2WDI	Brakes	Call for Pricing
horstWA-SBD	Spring Balancer (Double)	Call for Pricing



SPECIFICATIONS

Model	MKGW6500			MKGW12000
Extension	N/A	8"	12"	N/A
Capacity (Bushels)	645	745	800	1,200
Hopper Construction	12 GA.			12 GA.
Under Structure	4" x 8" .188" wall rectangular tubing			4x8x.25w
Unloading Door	57" width (standard) 28" width x2 (divider)			15" length x 47" width X 2
Chute Height	16"-20"			18"
Box Dimensions				
Length	229"	229"	229"	315"
Width	115"	115"	115"	110"
Height (less wagon)	91"	99"	103"	136"
Height (wagon & 22.5" wheel)	125"	133"	137"	156"
Weight (LBS.)	4,645	4,915	5,005	17,500
Wheel Base	156"			215"
Suggested Wagon	485 Horst Wagon - 425/22.5 Tires			608 Horst Wagon- 425/22.5 Tires (with brakes)
List Price	Call for Pricing	Call for Pricing	Call for Pricing	Call for Pricing
List Price c/w Horst Wagon*	Call for Pricing	Call for Pricing	Call for Pricing	
Suggested Wagon Included	485 Horst Wagon - 425/22.5 Tires (Reinforced Rims)			608 Horst Wagon- 425/22.5 Tires (with brakes)

Gravity Box Options



HYDRAULIC DOOR OPENER

Part # MKGW-HYD Door	Description	List Price
MKGW50HD	Hydraulic Door Opener (MK5000)	Call for Pricing
MKGW65HD	Hydraulic Door Opener (MK6500)	Call for Pricing



The Hydraulic Door allows you to conveniently control the metering of the material using a remote from your tractor.

DIVIDER KIT

Part #	Description	List Price
MKGW32DIV	Center Divider (MK3200)	Call for Pricing
MKGW50DIV	Center Divider (MK5000)	Call for Pricing
MKGW65DIV	Center Divider (MK6500)	Call for Pricing

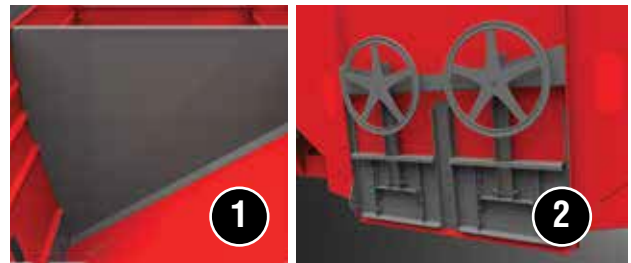

The optional divider splits your Gravity Box **1**, allowing for two separate commodities to be in the box at the same time. Each side also has it's own door for individual unloading and metering **2**.

UNLOADING AUGER

Adjustable hopper attaches to the exit door. Available in either stainless or black powder coated down spout.

Part #	Description	List Price
MKGWAT6X16	6" x 16' auger with cupped steel flighting & telescopic down spout.	Call for Pricing
MKGWAT8X16	8" x 16' auger with cupped steel flighting & telescopic down spout.	Call for Pricing
MKGWATSS6X16	6" x 16' stainless steel auger with cupped flighting & telescopic down spout	Call for Pricing
MKGWATSS8X16	8" x 16' stainless steel auger with cupped flighting & telescopic down spout	Call for Pricing





GRAIN SHIELD TARP KIT

Part #	Capacity	List Price
MKGW32TS	320-450	Call for Pricing
MKGW50TS	500-610	Call for Pricing
MKGW65TS	645-800	Call for Pricing
MKGW120TS	1200	Call for Pricing



This ratchet-free locking system not only protects the contents from blowing away and from inclement weather, but also locks quickly and easily so you can head out sooner.

**Comes standard on MKGW12000 model.*

REAR LADDER KIT

Part #	Description	List Price
MKGW32LAD	Fits 3200 Models	Call for Pricing
MKGW50LAD	Fits 5000 & 6500 Models	Call for Pricing



The optional rear ladder gives another access point for operators to look into the Gravity Box.

CENTER DUMP

Part #	Description	List Price
MKGW65CD	Center Dump for 5000 & 6500	Call for Pricing



The optional center dump directs the unloading material beneath the gravity box, ideal for when the unloading area isn't wide enough for standard side dumping.

Interseeder



SPECIFICATIONS

Model	11 Row	15 Row
Width	27.5"	37.5"
Weight (LBS.)	N/A	N/A
Category	Cat. 2 & 3	Cat. 2 & 3
List Price	Call for Pricing	Call for Pricing

Inter Seeder rolling tines create some soil disturbance improving the seed to soil contact. This improves the germination compared to seeds that are just broadcasted.

FEATURES

- Gandy 10 cubic feet Orbit Air seed applicator
- Multiple species seed capability
- 11 row 27 ½' width
- 15 row 37 ½' width
- Cat. 2 & 3 w/quick hitch compatibility
- Independent row units
- 30" row width
- Parking stands



FEATURES

- 12,000 LBS. capacity
- 3PH Mount Cat. 2 or 3 implements
- Hydraulically raise and lower caddy to desired height

OPTIONS

Part #	List Price
Clevis Hitch	Call for Pricing
Tank Mounts	Call for Pricing
750 GAL. Tank (SC40329)	Call for Pricing
Tie Down Strap Kit (SCX0000140N)	Call for Pricing
Weight Box/SCIC1700	Call for Pricing

SPECIFICATIONS

Model	SCIC250	SCIC1700
Width	125"	152"
MAX HP	250	500
Weight (LBS.)	3,560 **	7,750
Lift Cyl.	3-½ x 16	5 x 14
Lift Capacity (LBS.)	12,000	20,000
Category	Cat. 2 & 3	Cat. 4
Tires	12.5L	16.5 x 16.1
List Price	Call for Pricing	Call for Pricing

NOTE: Weight box is included in the price of the SCIC250

** Includes the weight of the weight box

Disc Mower Implement Caddy



FEATURES

- Ratchet adjustment standard
- Inline or offset caddy
- Height adjustable clevis hitch
- Includes toplinek
- Adjustable (width) lower points
- Maximum load 1,400 lbs.



ADJUSTABLE HITCH

Adjust the hitch to ensure your mower is level.

OPTIONS

- Hydraulic adjustment
- Inline hydraulic lock for transport



HYDRAULIC (OPTION)

Hydraulically lifts the mower up and down.

SPECIFICATIONS

Model	MKC1200	MKC1201
Weight (LBS.)	1,900	1,835
Max Implement Weight	1,400 lbs.	1,400 lbs.
Lift Cyl.	3x8	3x8
Tires	11L 15	11L 15
Main Frame	7x7 Tube	7x7 Tube
RPM	540	540
Driveline	#5	#5
List Price	Call for pricing	Call for pricing

Part #	List Price
Hydraulic Lift	Call for pricing



STACK N FOLD
TOOLBAR

*Stack and Fold Toolbar shown on SCIC1700 with optional weight box and 12 Row Strip Cat

The Stack N Fold Toolbar from MK Martin is designed to provide safe and easy transport of Strip Cat strip till systems. By stacking both end sections over the center section, the Stack N Fold Toolbar quickly reduces the overall width providing easier transport from field to field. The over centre design and locking pins ensure that the end sections remain securely in place during travel and when in storage.

Stack N Fold Toolbars can be configured with 2 to 4 remotes allowing you to control each side of the toolbar separately. This allows for easier service and maintenance, as well as for custom operations when you may not need the full width of the Strip Cat such as on headlands and point rows.



FEATURES

- Available from 8-Row to 18-Row
- Allows for parallel horizontal stacking of row units
- Ideal for transport and storage
- Equipped with 2 large cylinders (5x30 fold cyl.)
- Equipped with 2 small cylinders (2x4)
- Requires 2 to 4 remotes depending on configuration



Effective on products retailed on or after October 1, 2022

Seven Year Limited Consumer Warranty
90 Day Limited Commercial Warranty including Gearboxes

Commercial includes rental and industrial applications.

Warranty begins at the time of customer delivery and is activated upon warranty registration receipt at MK Martin Enterprise Inc.

Warranty coverage is null and void unless the Warranty Registration form has been **completed in full and is on file at MK Martin Enterprise Inc.**

Keep your registration copy in a safe place, it is required as proof of warranty activation.

This new and unused product is warranted by MK Martin Enterprise Inc. to be free from defects in material and workmanship under normal use and regular service as described in the owner's manual, for a consumer period of 7 years from the date of delivery, and commercial period of 90 days, including gearboxes, from the date of delivery. Warranty is limited to the replacement of parts and / or repair of the product.

If issues develop within the warranty period with the product, contact the local dealer from which you purchased the unit. Only MK Martin authorized dealers may make repairs to the product or affect the replacement of defective parts, unless otherwise approved by MK Martin. Repairs / replacement will be done at no charge within a reasonable time after the receipt of the product. This warranty does not cover the following items:

1. Normal replacement of service items.
2. Normal maintenance or adjustments.
3. Machines or parts lost or damaged during shipment,
4. Accessory items / parts not supplied by MK Martin
5. Damages resulting from:
misuse, negligence, accident, theft or fire
use of improper or insufficient fuel, fluids or lubricants
use of aftermarket parts or accessories, unless approved by MK Martin
modifications, alteration, tampering or improper repair
any device or accessories installed other than an authorized dealer.
6. Tires are covered by the manufacturer of the tire and the warranty period specified by that manufacturer. Please contact the tire manufacturer for warranty on these items.

MK Martin Enterprise Inc. shall not, in any event, be liable for any losses, damages or costs; to include profits, travel, transportation, pick up, delivery, towing cost, tow vehicle, loss of use, whether special, incidental, consequential or otherwise, in any way. Unit or parts are returned at the customer's expense.

Include a copy of your completed Warranty Registration form with any claim as proof of warranty activation. There are no warranties, expressed or implied, other than those specified herein. No agent, employee or other person has any authority to vary any of the foregoing provisions.

Warranty coverage is null and void unless the Warranty Registration form has been completed in full and is on file at MK Martin Enterprise Inc. Warranty begins at the time of customer delivery and is activated upon Warranty Registration receipt at MK Martin Enterprise Inc.

Custom/Standard Colors /Setup Fees

Standard Colors

Product	Standard Color
Gravity Box	Red, Green, or Blue
Snow Blowers	Charcoal or Red
Commercial Blowers/Throwers	Charcoal, Industrial Yellow
Rotary Cutters & Mowers	Charcoal, Industrial Yellow
Axis Tool Arms	Charcoal
Box Grader & Grader Blades	Charcoal
XD Grader Blades	Industrial Yellow
Land Leveler	Industrial Yellow
Grader Leveler	Industrial Yellow
Land Plane	Industrial Yellow
Track Curry	Industrial Yellow
Rotary Tiller	Charcoal
Landscape Rake	Charcoal
Cultivators	Charcoal
Weight Box	Charcoal
Dump Box	Charcoal
Interseeder	Charcoal

Custom Colours

Custom tractor match colours will be provided at no extra charge.

Setup Fees

Any other setup charges not listed will be subject to a rate of \$60.00/hr.

Product	Setup Fee
Gravity Box on Running Gear	Call for Pricing
Running Gear Assembly	Call for Pricing
Gravity Box Extension	Call for Pricing
Gravity Box Divider Installation	Call for Pricing
Tarp Kit Installation	Call for Pricing
Land Leveler Setup	Call for Pricing
Snowblower Setup	Call for Pricing
PT Snowblower Rear Blade	Call for Pricing
Cultivator Setup	Call for Pricing
Track Curry Setup	Call for Pricing
Rotary Cutters & Mowers	Call for Pricing
Rotary Cutter Chain Guard	Call for Pricing
Tool Arm & Cutter Setup	Call for Pricing
Brake Setup	Call for Pricing

LIVING COUNTRY

7 YEAR
WARRANTY



3950 Steffler Rd., Elmira Ontario, N3B 2Z3

Toll Free: 855-664-2752

Tel: 519-664-2752

Email: sales@mkmartin.ca

www.mkmartin.ca

Authorized Dealer

