



REIST
INDUSTRIES

PRODUCT CATALOGUE

MANUFACTURED IN CANADA

CONTENTS

LANDSCAPING

AERASEEDER (24" SELF PROPELLED)	5
AERASEEDER (3PH)	8
AUGER DRIVES (EARTH BOAR).....	16
AUGER DRIVE ACCESSORIES	18
DRAG MAT	21
IN-FIELDER	23
LANDSCAPER (CAT I)	32
LANDSCAPER (CAT II)	42
LIFT BUGGY (IRON ANT)	45
ROLLER (MULTI-PACKER)	48
ROLLER SELF-PROPELLED (LR30)	52
ROTORAKE	54
ROTORAKE - POWERSPUR	61
TRAIL PRO	64

ARENA GROOMING

MULTI-GROOMER	67
MULTI-GROOMER PONY	75
ROTO GROOMER	78

CALCULATE HYDRAULIC HORSEPOWER FROM HYDRAULIC OIL FLOW AND PRESSURE

psi x gpm ÷ 1714 X percentage efficiency (.80 to .95 is common) = HP

Example:

2500psi x 20gpm ÷ 1714 x .85 = 24.8 HP

AERASEEDER

LANDSCAPING



AOSCS48



AOSCS24SP

FEATURES

- Multi-spiked roller
- 850 perforations per square yard
- Honda engine with Eaton Hydrostatic Drive
- Rear smooth packing roller
- Cam-adjusted seed gate
- User-friendly controls
- Seed calibration tray

24" Self Propelled	AOSCS24SP	AOSCC24SP
Dimensions (WLH)	33 x 60 x 37"	
Seeding Width	24"	
Front Roller	Cone	Cone
Rear Roller	Smooth	Cone
Weight (lbs)	400	455
Seed Bin Capacity (Bushels)	1.25	

AERASEEDER 24"

GAUGE WHEEL



UHMW PLASTIC WHEELS

- 2" wide x 8" diameter solid rubber wheels
- Adjustable stop to control depth of penetration on front spike roller

**NOTE UPGRADE TO 4" WIDE UHMW PLASTIC WHEELS AVAILABLE*

REAR SPIKED ROLLER



- Additional spiked roller increases perforations to 1,700 per square yard

45-POUND WEIGHT



- Add weight for harder soil conditions to increase spike penetration.

WEIGHT BRACKET



- Holds up to six 45 pound weights

AERASEEDER 48"



AOSCS48

FEATURES

- The AeraSeeder was designed with efficiency in mind
- Internal agitator and bearing assembly deliver a smooth, constant seed flow
- The seed rate is achieved through an innovative locking knob adjustment control, allowing for maximum seed-spread accuracy
- The seed flow is turned on and off by a manual or hydraulic lever mechanism
- The tandem rollers oscillate 30 degrees on a pivot, allowing for consistent ground contact on rolling terrain
- The double-spiked rollers will leave over 1,700 perforations per square yard

Aeraseeder	AOSCS48
Dimensions (WLH)	52 x 36 x 21"
Seeding Width	44"
Hitch	CAT I
Weight (lbs)	460
Seed Bin Capacity (Bushels)	4.75

TOW CART



- Manual ratchet jack to raise and lower AeraSeeder on cart
- Cart attaches quickly to three-point hitch mounts on AeraSeeder

MANUAL SEED SLIDE SHUT-OFF

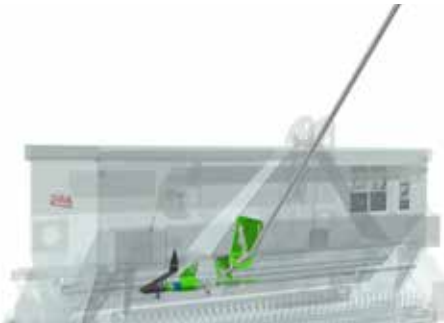

- Comes standard with hydraulic shut off
- Manual shut off is for tractors without hydraulic remotes

AERASEEDER 48" OPTIONS

REAR SPIKED ROLLER EXTENSION

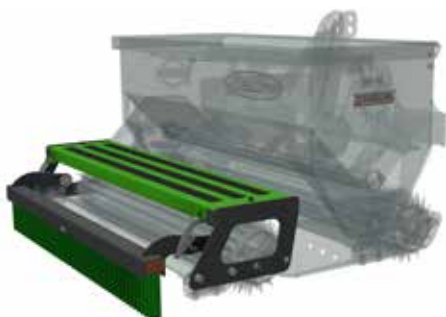

- Extends rear-spiked roller and brush back 7" for optimum ground contact and smoother operation
- Stand-on platform for easy loading of hopper

TOOL BARS- TWO OR THREE 48" AERASEEDERS



- CAT II Hitch
- Hydraulic control for seed slide opener

AERASEEDERS 60" - 96"



AOSCS72

FEATURES

- The AeraSeeder was designed with efficiency in mind
- Internal agitator and bearing assembly deliver a smooth, constant seed flow
- The seed rate is achieved through an innovative locking knob adjustment control, allowing for maximum seed-spread accuracy
- The seed flow is turned on and off by a manual or hydraulic lever mechanism
- The tandem rollers oscillate 30 degrees on a pivot, allowing for consistent ground contact on rolling terrain
- The double-spiked rollers will leave over 1700 perforations per square yard

Aeraseeder	AOSCS60	AOSCS72	AOSCS96
Width	69"	81"	105"
Seeding Width	60"	72"	96"
Hitch	CAT I	CAT I	CAT I
Weight (lbs)	1,020	1,185	1,400
Seed Bin Capacity (Bushels)	10	12	16

AERASEEDERS 60" - 96"

FRONT CONE & REAR SMOOTH



- Application: primary seeding & overseeding

FRONT KNIFE AND REAR KNIFE



- Application: Overseeding & root slicing
- Plant grass seed directly into existing turf

FRONT CONE & REAR CONE



- Application: Overseeding
- Plant grass seed directly into existing turf, without tearing up the turf, or the soil
- Leave over 1,700 perforations per square yard

REAR SPIKED ROLLER EXTENSION (72 & 96)



- Extends rear-spiked roller and brush back 7" for optimum ground contact and smoother operation
- Stand-on platform for easy loading of hopper

AERASEEDERS 60" - 96"

45-POUND WEIGHT



- Suitcase style weight

TOOL BAR — TWO 72" AERASEEDERS



- CAT II Hitch
- Hydraulic control for seed slide opener

TOOL BAR — THREE 72" AERASEEDERS



- CAT II Hitch
- Hydraulic control for seed slide opener

EARTH BOAR

LANDSCAPING



AS1530
SHOWN WITH USH100

EARTH BOAR AUGER DRIVES

FEATURES

- Robust compact planetary auger drive
- Mounts available for skid steer loaders, and tractor front end loaders
- Flow ranges between 6-35 GPM
- The AS series are ideal for farm, ranch, construction, and rental applications
- The AH model has higher torque output and has a field serviceable output shaft

Specifications	AS-0615	AS-1020	AS-1530	AS-2035	AH-1530
Dimensions (Drive only)	10 x 10 x 28 in				11 x 11 x 35 in
Weight Drive	150 lbs.	150 lbs.	150 lbs.	151 lbs.	185 lbs.
Output Shaft Size	2" Hex				
Max. Dia. Dirt	18 in	30 in	36 in	36 in	36 in
Max. Dia. Rock	18 in	24 in	36 in	36 in	36 in
Gear Train Type	Planetary				
Min./Max. Flow	6-15 GPM	10-20 GPM	15-30 GPM	20-35 GPM	15-30 GPM
Max. Continuous PSI	3000 PSI				
Max Intermittent PSI	3500 PSI				
Field Serviceable	No				Yes
Limited Warranty	4 YEARS				5 YEARS

TORQUE CHART & MOUNTS

Speed Output	AS-0615	AS-1020	AS-1530	AS-2035	AH-1530
6 GPM	36 RPM	NA	NA	NA	NA
10 GPM	61 RPM	53 RPM	NA	NA	NA
15 GPM	91 RPM	79 RPM	55 RPM	NA	45 RPM
20 GPM	NA	105 RPM	73 RPM	61 RPM	60 RPM
25 GPM	NA	NA	92 RPM	76 RPM	75 RPM
30 GPM	NA	NA	110 RPM	91 RPM	90 RPM
35 GPM	NA	NA	NA	106 RPM	NA

Torque Output	AS-0615	AS-1020	AS-1530	AS-2035	AH-1530
2000 PSI	1,008 ft. lbs.	1,165 ft. lbs.	1,674 ft. lbs.	2,016 ft. lbs.	2,041 ft. lbs.
2500 PSI	1,260 ft. lbs.	1,456 ft. lbs.	2,092 ft. lbs.	2,520 ft. lbs.	2,550 ft. lbs.
3000 PSI	1,512 ft. lbs.	1,747 ft. lbs.	2,511 ft. lbs.	3,025 ft. lbs.	3,062 ft. lbs.
3500 PSI	1,764 ft. lbs.	2,038 ft. lbs.	2,929 ft. lbs.	3,529 ft. lbs.	3,572 ft. lbs.

MOUNTS



UNIVERSAL WELD-ON
MOUNT FOR EXCAVATORS
AND BACKHOES



USH100BL



USH100



USH100MB



USH100M

DIRT AUGERS



- Suited for drilling in dis-placeable soils such as sand, silt, or clay
- Features a hardened cast boring
- Bolt-on tooth design
- 48" length
- Semi-Double flight design
- 5/16" Flighting
- 3.5" Diameter Pilot

ROCK AUGERS



- Suited for cutting through tough cobble, boulders, fractured, or solid rock
- Bullet teeth arranged at optimal cutting angles
- Bolt-on tooth design
- 48" length
- Semi-Double flight design
- 5/16" Flighting
- 3.5" Diameter Pilot

AUGER BITS

TREE SHRUB AUGERS



- Suited for drilling in dis-placeable soils such as sand, silt, or clay
- Features a hardened cast boring
- Bolt-on tooth design
- 48" length
- 5/16" Flighting
- 3.5" Diameter Pilot

ACCESSORIES



- Various extensions are available either as fixed or adjustable in 12" increments
- Adapters from round, square, and hex in multiple sizes
- Different mount types to mount the auger drives to your equipment
- Replaceable pilot and teeth to customize your auger

DRAG MAT

LANDSCAPING

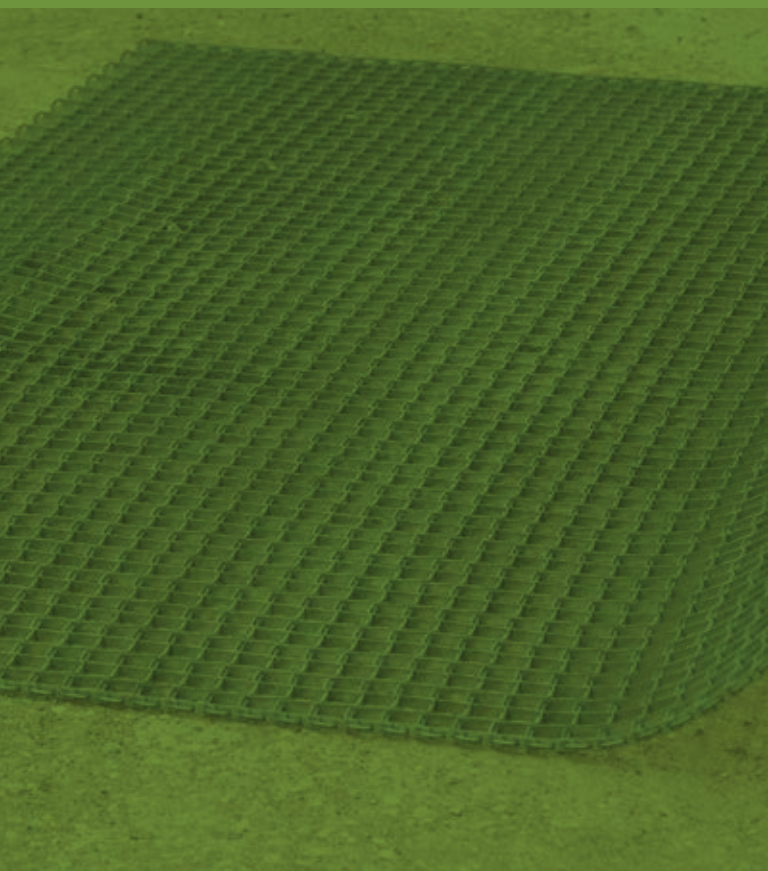

DM66

DRAG MAT

FEATURES

- Rolls up behind your bumper to transport with unique crank, folding handle and lock system
- Fits on to any 2" trailer hitch receiver

Drag Mat	DM66	DM84
Dimensions (WLH) <i>*HEIGHT IS ROLLED UP MAT</i>	73 x 20 x 10"	91 x 20 x 10"
Mesh Mat	1" sq. Stainless Steel Mesh	1" sq. Stainless Steel Mesh

OPTIONS

HITCH EXTENSION

- Often used for ATVs to move the Drag Mat up and away from wheels



IN-FIELDER

LANDSCAPING



D72

IN-FIELDER



D84

FEATURES

- Heavy duty bolt-on serrated grader blade
- Floating clod-breaking pulverizer roller
- Heavy duty floating leveling bar
- Floating rear brush (D60)
- Floating rear brush with side bumpers (D72 & D84)
- Broom and rake holders
- Adjustable rear brush
- Lubed pivots

In-Fielder	D60	D72	D84
Dimensions (WLH)	67 x 43 x 31"	80 x 48 x 32"	97 x 46 x 33"
Width	60"	72"	84"
Hitch	CAT I	CAT I	CAT I & II
Weight (lbs)	620	835	935
Pulverizer Roller	5"	5"	5"
Packer Roller	1 pc. Steel Roll	6" x 12" UHMW Rolls	6" x 12" UHMW Rolls

WATER TANK



- 50 gallon capacity
- 12V pump and rear nozzle

HAND WAND KIT



- Hand wand kit for easy spraying

FRONT NOZZLE KIT



- For dust suppression
- Front nozzle, switch and pump

ROTARY SWEEPER

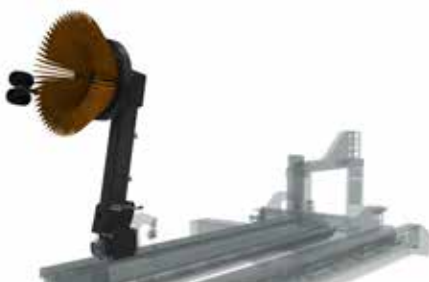

- 20" diameter nylon bristle brush with spring loaded break-away arm
- Hydraulic-driven
- Adjustable gauge wheel
- Sweep material off grass and away from fence
- Prevent out field ridge

TOW KIT WITH WHEELS (D60 & D72)



- Tow kit to tow In-Fielder

TOW KIT EXTENDED (D72)

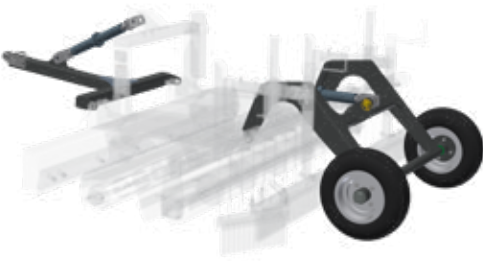

- Tow kit to tow D72 In-Fielder with long tine harrow option

ELECTRIC ACTUATOR

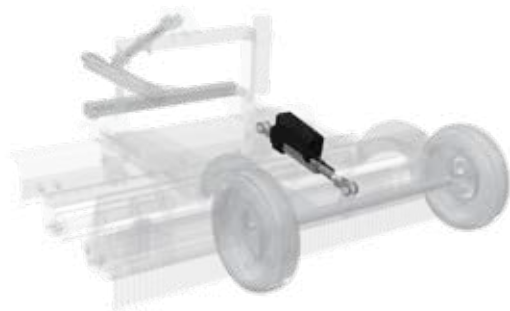

- 100mm Stroke

HYDRAULIC TOP LINK (CAT I & II)

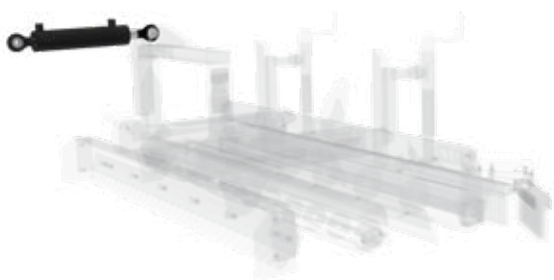

- Available for CAT I & CAT II
- Available in 8", 10" and 14" stroke lengths

EDGER



- Get the perfect edge

REAR LONG TINE RAKE FOR D60



- 14" long x 3/8" spring tines
- Loosen up hard-packed surfaces, which helps to dry the soil quicker

REAR LONG TINE RAKE FOR D72

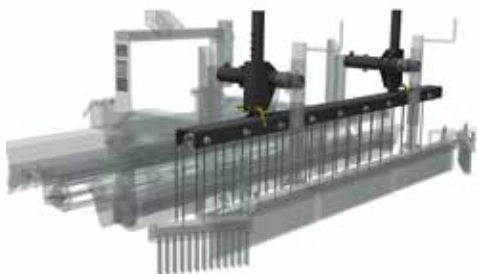

- 14" long x 3/8" spring tines
- Loosen up hard-packed surfaces, which helps to dry the soil quicker

REAR LONG TINE RAKE FOR D84



- 14" long x 3/8" spring tines
- Loosen up hard-packed surfaces, which helps to dry the soil quicker

SULKY



- Sulky fits between the UTV or ATV and the Infielder
- Required for UTVs or ATVs where the hitch moves with the suspension
- Keeps the Infielder level
- Sulky fits into a 2" receiver
- 21" wide x 20" long x 16" high
- 45 lbs. weight

LANDSCAPER

LANDSCAPING



P84



P84

FEATURES

- CAT I Hitch
- Horsepower varies depending on model
- Serrated heat-treated grader blade
- Rear pulverizing roller
- Adjustable side wear plates
- 10" high by 9" deep box
- 3/8" Side plates

Landscaper CAT I	P48	P60	P72	P84	P96
Dimensions (WLH)	49 x 38 x 33"	61 x 38 x 33"	73 x 38 x 33"	85 x 38 x 33"	97 x 38 x 33"
Working Width	48"	60"	72"	84"	96"
HP Req.	20-30	25-40	30-50	30-60	30-75
Hitch	CAT I	CAT I	CAT I	CAT I	CAT I
Weight (lbs)	350	570	701	745	833
Weight w/ Harrow (lbs)	400	631	784	835	937
Weight w/ Harrow & Ripper (lbs)	525	774	954	1,005	1,170
Weight w/ Seeder Attach. (lbs)	460	690	750	945	1,500

LANDSCAPER (CAT I)

HARROW (AVAILABLE FOR CAT I & II)



- Hardened 5/8" square teeth spaced at 2 1/2"
- Removes trash on surface
- Mixes grass seed into soil with seeder attachment
- Makes a nice seed bed
- Manual adjustment from 0-4" deep
- Manual ratchet jack to raise

HARROW CYLINDER

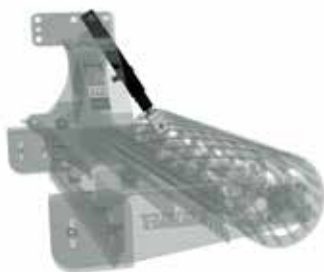

- Replaces manual ratchet jack to control ripper tooth depth hydraulically

SMOOTH ROLLER



- Smooth flat finish on soil, sand or synthetic
- Equestrian footings
- Self-adjusting scraper bar
- Water can be added to roll

6" HITCH EXTENSIONS



- Extension for more clearance

LANDSCAPER (CAT I)

HITCH ADAPTER, SKID STEER (PULL ONLY)



- Hitch adapter to attach to skid steer
- Pull only

HITCH ADAPTER, SKID STEER (PUSH AND PULL)



- Hitch adapter to attach to skid steer
- Ability to push and pull

HITCH ADAPTER, HYDRAULIC TILTING



- Hitch adapter to attach to skid steer, with hydraulic controls for tilts
- Ability to push and pull

HYDRAULIC TOP LINK CYLINDER



- Top link grading control
- 8" stroke CAT I
- 10" or 14" stroke CAT II
- Ball ends

LANDSCAPER (CAT I)

GRASS SEEDER



- Quick attach two-pin mounting system
- Seed rate adjustment with indicator
- Hydraulic-controlled seed opener or optional Manual
- Available widths and capacity:
 - 48" (2.7 bushels),
 - 60" (3.4 bushels), 72" (4.1 bushels),
 - 84" (4.9 bushels), and 96" (5.6 bushels)

RIPPER (AVAILABLE FOR CAT I & II)



- 1/2" thick x 2" wide bolt-on ripper teeth
- High-strength, stress-proof ripper bar
- Manual adjustment from 0 to 5" ripping depth
- Available widths: 48", 60", 72", 84" and 96"
- Manual ratchet jack to raise

REAR BRUSH (AVAILABLE FOR CAT I & II)

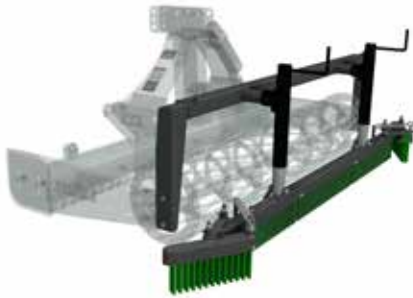

- Brushed finish on walking trails
- Break-away wings to smooth out side ridges
- Adjustable brush depth with two top wind jacks
- Available widths: 48", 60", 72", 84" and 96"

SWIVEL HITCH (AVAILABLE FOR CAT I & II)



- Turns 22 degrees each way
- Unique self-straightening feature when 3PH is raised
- Lock pin for hard surfaces
- Hitch extensions required

LANDSCAPER (CAT I)

BOARD SCRAPER



- Get a nice finish from your machine even close to boards of arenas with the board scraper attachment
- Thick rubber to not damage boards

RIPPER CYLINDER



- Replaces manual ratchet jack to control ripper
- Adjust tooth depth hydraulically
- 2"x 8" Cylinder

SPIKED ROLLING HARROW



- Ideal for prepping seed beds
- For CAT I & II
- Manual ratched jack adjustment
- To break up clumps

LANDSCAPER (CAT II)



P96H

FEATURES

- CAT II Hitch
- 70-120 horsepower
- Serrated heat-treated grader blade
- Rear pulverizing roller
- Adjustable side wear plates
- 18" high by 17" deep box
- ½" Side plates

Landscaper CAT II	P96H
Dimensions (WLH)	99 x 46 x 34"
Working Width	96"
HP Req.	70-120
Hitch	CAT II
Weight (lbs)	945
Weight w/ Harrow (lbs)	1,060
Weight w/ Harrow & Ripper (lbs)	1,260

RIPPER



- 1/2" thick x 2" wide bolt-on ripper teeth
- High-strength, stress-proof ripper bar
- Manual adjustment from 0 to 5" ripping depth
- Available widths: 48", 60", 72", 84" and 96"
- Manual ratchet jack to raise

HARROW



- Hardened 5/8" square teeth spaced at 2 1/2"
- Removes trash on surface
- Mixes grass seed into soil with seeder attachment
- Makes a nice seed bed
- Manual adjustment from 0-4" deep
- Manual ratchet jack to raise

REAR BRUSH



- Brushed finish on walking trails
- Break-away wings to smooth out side ridges
- Adjustable brush depth with two top wind jacks
- Available widths: 48", 60", 72", 84" and 96"

IRON ANT

LANDSCAPING



1A30

IRON ANT



IA30

FEATURES

- Designed to move compactors plates onto truck then to desired location at the construction site
- Or move anything that can be lifted such as landscape rocks, tree balls, various building materials
- Requires two high torque cordless drills (NOT INCLUDED)

Iron Ant	IA30
Capacity (lbs)	1,200
Lifting Height	44"
Lifting Width	30"
Dimensions (WLH)	47.5 x 45 x 56.5"
Unit Weight (lbs)	280

PALLET FORK ATTACHMENT



- Ideal attachment for lifting small pallets and other items designed for use with pallet forks.
- Lifting Capacity 600 lbs.
- Tine spacing 17" or 18" centers
- Tine height 2"
- Dimensions (WLH) 18 x 33 x 37"
- Unit weight 40 lbs.

MULTI-PACKER

LANDSCAPING



MP72
* SHOWN WITH OPTIONS

FEATURES

- Slots for optional ripper teeth
- Floating drum scraper
- 24" diameter steel drum
- Drum can be filled with water for increased compaction
- Storage stand
- Mounts for optional leveling blade
- CAT I and II Hitch

Multi-Packer	MP36	MP48	MP60
Dimensions (WLH)	40 x 30 x 37"	52 x 30 x 37"	64 x 30 x 37"
Working Width	36"	48"	60"
Steel Drum Diameter	24"	24"	24"
Weight lbs (Dry)	565	610	712
Weight lbs (w/ Water)	960	1,190	1,460

Multi-Packer	MP72	MP84	MP96
Dimensions (WLH)	76 x 30 x 37"	88 x 30 x 37"	100 x 30 x 37"
Working Width	72"	80"	96"
Steel Drum Diameter	24"	24"	24"
Weight lbs (Dry)	815	940	1,025
Weight lbs (w/ Water)	1,765	1,930	2,300

MULTI-PACKER

RIPPER TEETH



- Ripper teeth to rip up and soften ground
- Adjustable in 1" increments

LEVELING BLADE



- Redistributes and levels material

TOW HITCH



- Add tow hitch to tow behind tractor or appropriate vehicle

REPLACEABLE PARTS

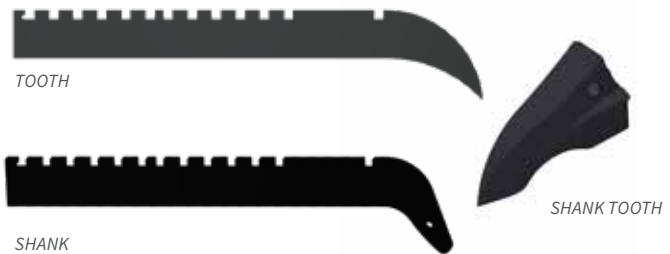

- Replaceable:
 - Teeth
 - Shanks & Shank Teeth
- Resistant to wear

LR30 LAWN ROLLER

LANDSCAPING



LR30

FEATURES

- Operates forward and reverse
- Unit Easily movable without starting the engine
- Powered by a 5.5 horsepower Honda gasoline engine
- Eaton hydrostatic transmission
- Power is delivered to the drum with a series sprockets, jack shaft and chains

Lawn Roller Self Propelled	LR30
Dimensions (WLH)	35 x 60 x 48"
Drum Diameter	30" x 24"
Weight lbs (Dry)	480
Weight lbs (w/ Water)	880

OPTIONS

RIDE ON ATTACHMENT KIT

- Kit includes a pin on seat and roller allowing the operator to run the unit while seated.
- Ideal for large properties



ROTORAKE

LANDSCAPING



RR84 *

RR72PTO18G *

* SHOWN WITH OPTIONS



RR48

FEATURES

- Manual adjustment
- No tilt

RotoRake	RR48-R	RR48
Dimensions (WLH)	57 x 55 x 28"	57 x 55 x 28"
Working Width	48"	48"
Working Width (Angled 25°)	44"	44"
Weight (lbs)	725	725
Cont. PSI	3,000 MAX	3,000 MAX
PTO Required	N/A	N/A
Roto Speed	230-450 RPM	230-450 RPM
Hyd. GPM Range	12-20	12-20
Rotor Torque @ 2500 PSI	325 ft-lbs	325 ft-lbs
Mount Type	Mini Skidsteer	Mini Skidsteer (Bobcat)
Gauge Wheels Included	1	1
Angle	Manual	Manual

ROTORAKE



D-72 MODEL
* SHOWN WITH
OPTIONS

FEATURES

- Features a 25 degree angle and 28 degree tilt for easy swaling and ditching
- Oscillating gauge wheels lock in level position for the (PTO) three point hitch use
- Dual-motor design delivers 40% more torque than a single motor, and eliminates outside bearings and chains

RotoRake	RR60	RR72	RR84	RR96
Dimensions (WLH)	69 x 63 x 34"	81 x 63 x 34"	93 x 63 x 34"	105 x 63 x 34"
Working Width	60"	72"	84"	96"
Working Width (Angled 25°)	55"	65"	76"	87"
Weight (lbs)	1,150	1,220	1,280	1,380
Cont. PSI	3,000 MAX	3,000 MAX	3,000 MAX	3,000 MAX
PTO Required	N/A	N/A	N/A	N/A
Roto Speed	230-450 RPM	230-450 RPM	230-450 RPM	230-450 RPM
Hyd. GPM Range	18-30	18-30	18-30	18-30
Rotor Torque @ 2500 PSI	550 ft-lbs	550 ft-lbs	550 ft-lbs	640 ft-lbs
Mount Type	Std. Skid.	Std. Skid.	Std. Skid.	Std. Skid.
Gauge Wheels Included	2	2	2	2
Tilt	Manual	Manual	Manual	Manual
Angle	Manual	Manual	Manual	Manual

REMOTE-CONTROLLED HYDRAULIC KIT



- Hydraulic option for the RotoRake
- 12 volt Hydraulic valve option to tilt and angle
- You can choose one or both of these options
- The optional On The Fly Valve keeps the rotor spinning while tilting the rotor

SIDE CUTTERS

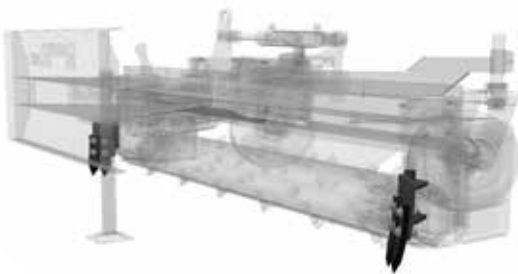

- Pin on front or rear depending on desired direction of travel
- When ditching, the side cutters help to dig in further

ROTORAKE OPTIONS

CAT I HITCH

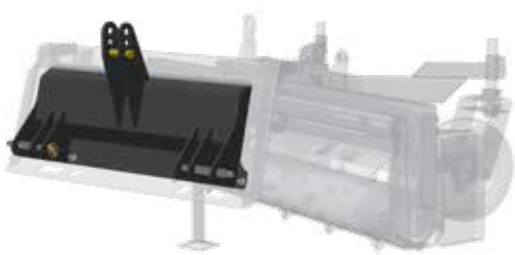

- CAT I & II hitch for your RotoRake

WIRING HARNESS



DIRECT



MANUAL

- Contact Reist Industries or your local dealer for available wiring kits.



RR72PTO18G
* SHOWN WITH OPTIONS

- Power take-off for your RotoRake unit
- Drives a pump which drives the rotor motors
- No chains or sprockets
- No shear pins or seized slip clutches

RotoRake	RR60PTO18G	RR72PTO18G	RR84PTO18G
Dimensions (WLH)	69 x 63 x 34"	81 x 63 x 34"	93 x 63 x 34"
Working Width	60"	72"	84"
Weight (lbs)	1,350	1,420	1,500
Cont. PSI	3,000 MAX	3,000 MAX	3,000 MAX
PTO Required	540RPM	540RPM	540RPM
Roto Speed	230-450 RPM	230-450 RPM	230-450 RPM
Hyd. GPM Range	18-30	18-30	18-30
Rotor Torque @ 2500 PSI	550 ft-lbs	550 ft-lbs	550 ft-lbs
Mount Type	3PH Cat 1 & 2	3PH Cat 1 & 2	3PH Cat 1 & 2
Gauge Wheels Included	2	2	2

ROTORAKE PTO OPTIONS

FOAM FILLED TIRES

- Uses the same tire as air filled
- Weighs 39 lbs. (24 lbs. heavier than air filled)

TILT CYLINDER & HOSE KIT (PTO ONLY)

- Used on tractor remotes
- Requires a second set of remotes

SIDE CUTTERS

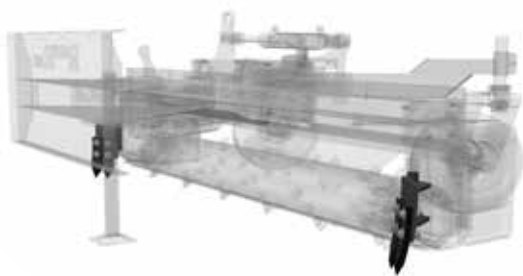

- Pin on front or rear depending on desired direction of travel

POWER SPUR

LANDSCAPING



PROTOTYPE SHOWN



PS72

POWER SPUR



PS72

FEATURES

- Adjustable mount allows you to adjust the adapter to maintain proper engagement depth of the rotor
- Floating Rotor helps to prevent the rotor from binding - the rotor housing and ledger are constructed of AR400 steel

Power Spur	PS72	PS84
Dimensions (WLH)	79 x 20 x 25"	91 x 20 x 25"
Working Width	72"	84"
Overall Width	79"	91"
Suggested Bucket Width	78 - 84"	90 - 96"
Weight (lbs)	720	770
Cont. PSI	3,000 MAX	3,000 MAX
Roto Speed	230-450 RPM	230-450 RPM
Hyd. GPM Range	18-30	18-30
Rotor Torque @ 2500 PSI	550 ft-lbs	550 ft-lbs
Mount Type	Std. Skidsteer	Std. Skidsteer

POWER SPUR WHEEL ATTACHMENT (PSWA)



- Attaches to the front of the power spur to maintain depth.
- Adds approx. 17.5" to the overall length of the Power Spur.

FOAM FILLED TIRES

- Uses the same tire as air filled
- Weighs 39 lbs. (24 lbs. heavier than air filled)

TRAIL PRO

LANDSCAPING



TP72



TP72

FEATURES

- Reclaim & reuse trail material
- Angled blades removes high spots and level the trail
- Spinning rotor pulverizes and separates root balls and stone dust
- Carbide-tipped teeth spins at 540 RPM
- Leveling plate made from $\frac{3}{4}$ " wear resistant steel
- Unique edging disc (one on each side) removes grass and weeds from side of trail
- Hydraulic top link is included

TrailPro	TP50	TP60	TP72	TP96
Dimensions (WLH)	55 x 66 x 34"	67 x 66 x 34"	79 x 66 x 34"	103 x 66 x 34"
Working Width	50"	60"	72"	96"
Weight lbs	1,250	1,475	1,600	1,900
Hitch	CAT I	CAT I	CAT I	CAT II
Power	540 PTO	540 PTO	540 PTO	540 PTO

REAR GAUGE ROLLER



- Packs down materials that cannot be drag-packed, such as wood chips and loose material

MULTI-GROOMER

ARENA GROOMING



MGP72

MG60

MULTI-GROOMER



MG60

Multi-Groomer	MG48	MG60	MG72
Dimensions (WLH)	49 x 68 x 32"	61 x 68 x 32"	73 x 72 x 32"
Working Width	48"	60"	72"
Working Depth	4"	4"	4"
Hitch	CAT I	CAT I	CAT I
Weight (lbs)	580	690	750
Tires	16.5 x 6.5-8	16.5 x 6.5-8	20.5 x 8.0-10
# of Ripper Teeth	11	15	19
Rear Bar Roller (dia.)	12.75"	12.75"	12.75"
HP Required	15 -40	20 -40	25-70

FEATURES

- Heavy duty side rub rails
- Double row of adjustable ripper teeth are offset and have a spacing of 4" (and can also be spaced 6" & 8" apart) as well as a working depth of up to 4"
- The rear two rows of spring tines are offset and the pitch and height can be adjusted with a manual ratchet rack or an optional hydraulic cylinder
- The rear bar roller pulverizes and packs to the desired density

Multi-Groomer	MG80	MG96	MG120
Dimensions (WLH)	81 x 72 x 32"	97 x 72 x 32"	121 x 72 x 32"
Working Width	80"	96"	120"
Working Depth	4"	4"	4"
Hitch	CAT I	CAT II	CAT II
Weight (lbs)	875	945	1,500
Tires	20.5 x 8.0-10	20.5 x 8.0-10	20.5 x 8.0-10
# of Ripper Teeth	19	23	31
Rear Bar Roller (dia.)	12.75"	12.75"	12.75"
HP Required	30-100	30-100	50-120

MULTI-GROOMER

CAT I SWIVEL HITCH



- Swivel hitch (CAT I)
- Turns 22 degrees each way
- Unique self-straightening feature when 3PH is raised
- Lock pin for hard and tough footings

CAT II SWIVEL HITCH



- CAT II Hitch for CAT II tractors
- Turns 22 degrees each way
- Unique self-straightening feature when 3PH is raised
- Lock pin for hard and tough footings

BOARD SCRAPER



- Get a nice finish from your machine even close to boards of arenas with the board scraper attachment
- Thick rubber to not damage boards

SAW TOOTH LEVELING BLADE

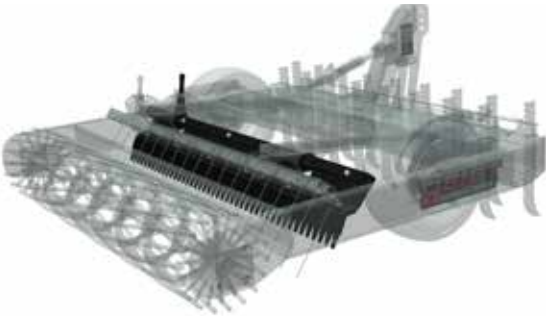

- Levels sand footing

MULTI-GROOMER

REPLACEABLE PARTS

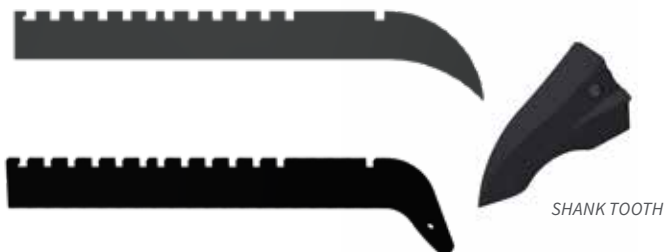

- Replaceable:
 - Teeth
 - Shanks & Shank Teeth
- Resistant to wear

TOW HITCH



- Add to hitch to tow behind tractor or appropriate vehicle

SMOOTH ROLL WATER TANK

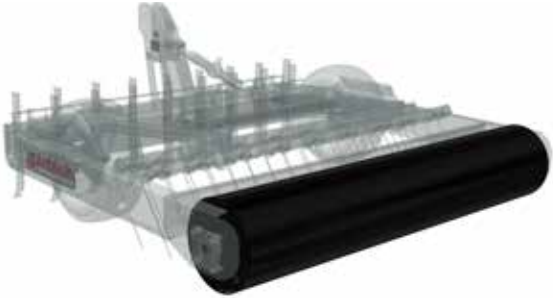

- Add this attachment to get the smoothest finish
- Add water for more compaction

HYDRAULIC LIFT AXLE



- Hydraulically control depth of ripper teeth with axle adjustment

MULTI-GROOMER OPTIONS

DRAG PACKER/SEALER



- Pack and seal up synthetic footings
- Hydraulic lift

HYDRAULIC RIPPER BAR

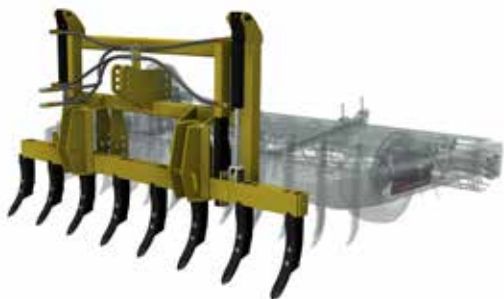

- Aggressive ripper
- Depth up to 8" deep
- Hydraulically lift ripper out of the way
- Connects to 3PH of MultiGroomer

MULTI-GROOMER PONY



MGP72

FEATURES

- Heavy duty side rub rails
- Double row of ripper teeth are offset and have a spacing of 4” as well as a working depth of up to 4”
- The rear two rows of spring tines are offset and the pitch and height can be adjusted with a manual ratchet rack or the optional hydraulic cylinder
- The rear bar roller pulverizes and packs to the desired density

Multi-Groomer PONY	MGP48	MGP60	MGP72	MGP84
Dimensions (WLH)	46 x 51 x 34”	58 x 51 x 34”	73 x 51 x 34”	85 x 51 x 34”
Working Width	48”	60”	72”	84”
Working Depth	4”	4”	4”	4”
Hitch	CAT I	CAT I	CAT I	CAT I
Weight (lbs)	330	385	475	550
Tires	16.5 x 6.5-8	16.5 x 6.5-8	20.5 x 8.0-10	20.5 x 8.0-10
# of Ripper Teeth	11	15	17	19
Rear Bar Roller (Dia.)	8.75”	8.75”	8.75”	8.75”
HP Required	25 MAX	25 MAX	35 MAX	35 MAX

MULTI-GROOMER PONY

SWIVEL HITCH CAT I



- Turns 22 degrees each way
- Unique self-straightening feature when 3PH is raised
- Lock pin for hard and tough footings

LEVELING BLADE



- Levels sand footing

REAR WHEEL KIT



- Drop and lock wheels down manually to transport

TOW HITCH



- Add tow hitch to tow behind tractor or appropriate vehicle

ROTO GROOMER

ARENA GROOMING



PTORG72



PTORG72

FEATURES

- Carbide toothed single direction drive rotor
- PTO Driven 540 RPM with slip clutch protection
- 12” rear smooth packing roll with self-adjusting scraper
- Water can be added to rear packer roll for extra weight

RotoGroomer	PTORG72	PTORG96
HP Required	20-80	40-80
Working Width	72”	96”
Height	30”	30”
Weight (lbs)	800	1,000
Hitch	CAT I	CAT II
Drum Speed (RPM)	200	200

ROTO GROOMER

PULVERIZER ROLLER



- Replaces smooth packer roller for a patterned finish

RIPPER BAR



- Ripper bar add on for the RotoGroomer to rip up ground and mix footing material
- Ripper height adjusts in 1" increments
- Teeth can be spaced at 8, 12 & 16"

BOARD SCRAPER



- Get a nice finish from your machine even close to boards of arenas with the board scraper attachment
- Thick rubber to not damage boards

FLOATING SPILL SHIELD KIT



- Stop overflow spillage with this shield kit

ROTO GROOMER OPTIONS

CAT I SWIVEL HITCH



- Turns 22 degrees each way
- Unique self-straightening feature when 3PH is raised
- Lock pin for hard and tough footings

CAT II SWIVEL HITCH



- Turns 22 degrees each way
- Unique self-straightening feature when 3PH is raised
- Lock pin for hard and tough footings



Founded in 1947, Reist Industries specializes in equipment for turf management, landscaping, as well as arena and trail grooming.

Our focused attention and strategic partnerships, allows Reist to identify specific industry needs and develop equipment that provides consistent performance over a wider variety of conditions.

Situated in Ontario Canada, REIST partners with equipment distributors, dealers and rental shops ensuring both professionals and homeowners have access to our innovative products.

MANUFACTURED IN CANADA

100 Union Street
Elmira, Ontario, Canada
N3B 3L7

Phone: 519-669-1501
Fax: 519-669-3021
Toll Free: 1-877-467-3478
www.reistindustries.com

23027-02 | Printed in Canada
E & OE | April 2023